



**United
Technologies**

Climate | Controls | Security

GRAVINER[®]

Mk 7 OIL MIST DETECTOR

INSTALLATION, OPERATION AND MAINTENANCE MANUAL

59812-K007

PROPRIETY RIGHTS NOTICE

The information contained in this manual is the property of UTC Fire & Security UK Ltd and may not be reproduced or transmitted in any form or by any means, electronic, mechanical, photocopying, recording or otherwise, nor stored in any retrieval system or any nature without the express written authority of UTC Fire & Security UK Ltd.

© Copyright 2017 UTC Fire & Security UK Ltd

TABLE OF CONTENTS

Chapter	Page
1 DESCRIPTION AND OPERATION.....	1
1.1 INTRODUCTION	1
1.2 DESCRIPTION	2
1.3 TECHNICAL SPECIFICATION	5
1.4 SYSTEM OVERVIEW	7
2 INSTALLATION AND COMMISSIONING	9
2.1 CONTROL UNIT MOUNTING	9
2.2 DETECTOR MOUNTING	11
2.3 DETECTOR CABLES	14
2.4 REMOTE DISPLAY UNIT	17
2.5 CONTROL UNIT	20
2.6 REMOTE DISPLAY UNIT	23
2.7 CONNECTING THE SYSTEM	27
2.8 SYSTEM CHECKS PRIOR TO SWITCHING ON	29
2.9 SYSTEM SETUP / CONFIGURATION – WITH A REMOTE DISPLAY UNIT	30
2.10 ISOLATION – USING THE REMOTE DISPLAY UNIT	51
2.11 TEST MENU & EVENT LOG	59
3 MAINTENANCE	67
3.1 ROUTINE MAINTENANCE	67
3.2 DETECTOR HEAD REPLACEMENT	68
3.3 DETECTOR HEAD REFURBISHMENT	69
3.4 FAN REPLACEMENT	72
3.5 CABLE REPLACEMENT	72
3.6 CONTROL UNIT MEMBRANE	73
3.7 CONTROL UNIT PCB REPLACEMENT	73
3.8 DECOMMISSIONING	73
4 FAULT FINDING	74
4.1 GENERAL	74
4.2 COMPLETE SPARE PARTS LIST	97


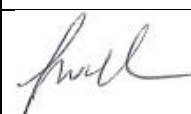



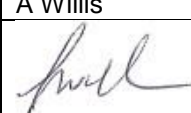

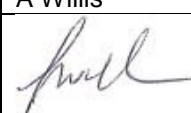

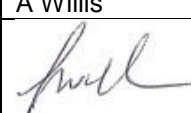



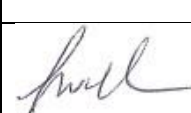



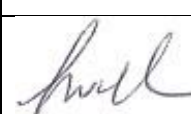

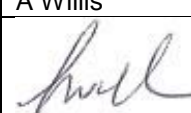
LIST OF ILLUSTRATIONS


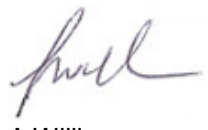



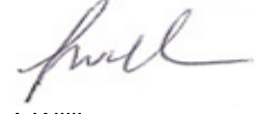
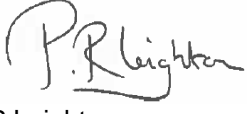
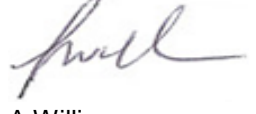
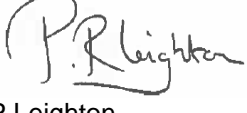
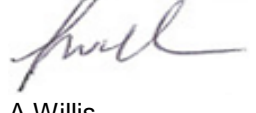
Figure Title	Page	
Figure 1	Areas of Failure – 2 Stroke Engine	1
Figure 2	Areas of Failure – 4 Stroke Engine	1
Figure 3	Graviner Mk7 OMD Components	2
Figure 4	Typical System Configuration – With Membrane	3
Figure 5	Typical System Configuration – Without Membrane	4
Figure 6	Relay Function Modes	8
Figure 7	Control Unit 1-53836-K270 (With Membrane)	9
(Caterpillar 1-53836-K270-01)		9
Figure 8	Control Unit 1-53836-K276 (Without Membrane)	10
Figure 9	Ideal Mounting Position	11
Figure 10	Detector Head Installation	12
Figure 11	Detector Head Installation (Short Sample Pipe)	13
Figure 12	Detector Cable	14
Figure 13	Detector Cable Assembly (Straight Connector)	15
Figure 14	Detector Cable Assembly (Right Angle Connector)	16
Figure 15	Flush Mounting Cut-out for Remote Display Unit	17
Figure 16	Flush Mounting for Remote Display Unit	18
Figure 17	Bulk Head Mounting for Remote Display Unit	19
Figure 18	Control Unit PCB	21
Figure 19	Wiring Drawing	22
Figure 20	24v DC Socket Wiring Drawing	23
Figure 21	Modbus Connector Wiring Drawing	24
Figure 22	Remote Display Unit 1-53836-K271	25
Figure 23	Terminal Block Connection	25
Figure 24	Junction Box Connection	26
Figure 25	Inline Connector	26
Figure 26	Power cable	27
Figure 27	Power cable through EMC gland	27
Figure 28	Control unit relay cable assembly	28
Figure 29	Detector cable assembly	28
Figure 30	Control unit - Detector cable assembly	29
Figure 31	Screen Shot 1	30
Figure 32	Screen Shot 2	30
Figure 33	Screen Shot 3	30
Figure 34	Screen Shot 4	31
Figure 35	Screen Shot 5	31
Figure 36	Screen Shot 6	31
Figure 37	Screen Shot 7	31
Figure 38	Screen Shot 8	34
Figure 39	Screen Shot 9	34
Figure 40	Screen Shot 10	34
Figure 41	Screen Shot 11	34
Figure 42	Screen Shot 12	35
Figure 43	Screen Shot 13	35
Figure 44	Screen Shot 14	35
Figure 45	Screen Shot 15	35
Figure 46	Screen Shot 16	36
	36	
Figure 47	Screen Shot 17	36
Figure 48	Screen Shot 18	36
Figure 49	Screen Shot 19	36

Figure 50	Screen Shot 20	39
Figure 51	Screen Shot 21	39
Figure 52	Screen Shot 22	39
Figure 53	Screen Shot 23	39
Figure 54	Screen Shot 24	40
Figure 55	Control Unit Membrane	41
Figure 56	Control Unit Membrane	42
Figure 57	Control Unit – USB Connector	43
Figure 58	Computer Connection – Type A USB Connector	43
Figure 59	USB Screen Shot 1	44
Figure 60	USB Screen Shot 2	44
Figure 61	USB Screen Shot 3	44
Figure 62	Detect Engine Screen Shot 1	45
Figure 63	Detect Engine Screen Shot 2	45
Figure 64	Detect Engine Screen Shot 3	45
Figure 65	Detect Engine Screen Shot 4	45
Figure 66	Detect Engine Screen Shot 5	46
Figure 67	Smoke Tester	47
Figure 68	Smoke Test	48
Figure 69	Screen Shot 25	51
Figure 70	Screen Shot 26	51
Figure 71	Screen Shot 27	51
Figure 72	Screen Shot 28	52
Figure 73	Screen Shot 29	52
Figure 74	Screen Shot 30	52
Figure 75	Screen Shot 31	52
Figure 76	Screen Shot 32	53
Figure 77	Screen Shot 33	53
Figure 78	Screen Shot 34	53
Figure 79	Screen Shot 35	53
Figure 80	Screen Shot 36	54
Figure 81	Screen Shot 37	54
Figure 82	Screen Shot 38	54
Figure 83	Screen Shot 39	54
Figure 84	Screen Shot 40	55
Figure 85	Screen Shot 41	55
Figure 86	Screen Shot 42	55
Figure 87	Screen Shot 43	55
Figure 88	Screen Shot 44	56
Figure 89	Screen Shot 45	56
Figure 90	Screen Shot 46	56
Figure 91	Screen Shot 47	56
Figure 92	Screen Shot 48	57
Figure 93	Screen Shot 49	57
Figure 94	Screen Shot 50	57
Figure 95	Screen Shot 51	57
Figure 96	Control Unit Membrane	58
Figure 97	Screen Shot 52	59
Figure 98	Screen Shot 53	59
Figure 99	Screen Shot 54	59
Figure 100	Screen Shot 55	60
Figure 101	Screen Shot 56	60
Figure 102	Screen Shot 57	60
Figure 103	Screen Shot 58	60
Figure 104	Screen Shot 59	61

Figure 105	Screen Shot 60	61
Figure 106	Screen Shot 61	61
Figure 107	Screen Shot 62	61
Figure 108	Screen Shot 63	62
Figure 109	Screen Shot 64	62
Figure 110	Screen Shot 65	62
Figure 111	Screen Shot 66	62
Figure 112	Screen Shot 67	63
Figure 113	Screen Shot 68	63
Figure 114	Screen Shot 70	64
Figure 115	Screen Shot 71	64
Figure 116	Screen Shot 72	64
Figure 117	Screen Shot 73	65
Figure 118	Screen Shot 74	65
Figure 119	Screen Shot 75	65
Figure 121	Base Fixing Screw Removal	68
Figure 122	Cable Disconnect	69
Figure 123	Base Moulding Seal	69
Figure 124	Pulling Tool	70
Figure 125	Fan Removal	70
Figure 126	Cleaning Light Guide	71
Figure 127	Control Unit Spares	92
Figure 128	Display Unit Spares	94
Figure 129	Detector Spares	95
Figure 130	Caterpillar Detector with Short Sample Pipe Part Number 1-53836-K269-03	101
Figure 131	Caterpillar Detector with Standard Sample Pipe Part Number 1-53836-K269-02	102

REVISION HISTORY

Issue	Date Of Issue	Revision History	Amended by	Approved by
1	Oct 2011	Draft – For Approval	 M Daley	 A Willis
2	Nov 2011	Approved for Distribution	 M Daley	 A Willis
3	Jan 2012	Changes to Back Alarm operating philosophy and Smoke Test procedure.	 M Daley	 A Willis
4	May 2012	Changes to Warranty section, addition of default values.	 M Daley	 A Willis
5	June 2012	Changes to Connector Push In part number.	 M Daley	 A Willis
6	Dec 2012	Updated Wiring Drawing and Connector Drawings. Addition of Short Sample Base in Parts List. Addition of Non Membrane units.	 M Daley	 A Willis
7	Jan 2013	Changes to Page Numbers	 M Daley	 A Willis
8	Jan 2013	Modification of Power Supplies required. Addition of Modbus addressing via Membrane. Update Fault Finding and Flow Charts to include Error Detecting Engines	 M Daley	 A Willis
9	Feb 2013	Additional note when setting Modbus address	 M Daley	 A Willis
10	July 2013	Change to Fan Connector and 24VDC Touch Screen Cable.	 M Daley	 A Willis

11	December 13	Figure 15 updated and specific part numbers for Caterpillar Control Unit added	 P Darnell	 A Willis
12	July 14	New part numbers and drawings included for Caterpillar in Addendum 1	 P Darnell	 A Willis
13	July 2016	Modified drawings and comments included	 P Leighton	 A Willis
14	June 2017	Control Unit software P66200-108, Remote Display Unit software P66300-103 support additional Engine and Detector names, System Test log added to Engineer level Control Unit & RDU floating psu and data connection guidance added.	 P. Leighton	 A. Willis
15	Nov 2017	Removal of the Detector Harness Kit and Control Unit Connector Kit as Spare Parts.	 P. Leighton	 A. Willis

OIL MIST DETECTOR WARRANTIES

1. UTC Fire & Security UK Ltd (UTC) warrants, for a period of 3 years from the handover of the new vessel which is installed with Graviner Mk7 Oil Mist Detector (OMD) system to the system owner, and for a period of 2 years from the commissioning⁽⁷⁾ date of a retro fitted Mk7 Oil Mist Detector (OMD) system, that any component forming part of the original OMD system manufactured by or supplied by UTC shall be free from defects in workmanship or materials during normal usage (the "OMD System Warranty"). If any such component does not conform to this warranty UTC will, at its sole discretion and its cost, either repair or replace such component. Installation of the repaired / replacement parts is not covered under the OMD System Warranty. Components replaced or repaired under the terms of the OMD System Warranty shall continue to have the benefit of the unexpired portion of the OMD System Warranty, unless that unexpired portion is less than 12 months, in which case the repaired / replacement parts shall have the benefit of a 12 month warranty against defects in workmanship or materials during normal usage starting on the date of delivery. OMD's supplied as spares shall be warranted in accordance with paragraph 2 below only.

2. UTC warrants for a period of 12 months from delivery that individual OMD's supplied as spares shall be free from defects in workmanship or materials during normal usage.

3. Performance of UTC's repair or replacement obligations shall constitute an entire discharge of UTC's liability under the warranties set out in paragraphs 1 and 2 above ("Warranties").

4. The Warranties shall not apply to the following:
 - a. defects reasonably judged by UTC as being caused by the improper installation of the OMD's and/or OMD system;
 - b. defects reasonably judged by UTC as being caused by the failure to follow the recommendations contained in UTC's product manuals and/or other documentation regarding the frequency of routine maintenance and testing of the OMD's and/or OMD system and/or the failure to have such routine maintenance performed;
 - c. defects which are attributable to careless handling or storage, accident, improper use of the OMD's and/or OMD system, or incorrectly completed repairs or routine maintenance services;
 - d. damages or losses occurring as a result of any act or omission which is wilfully unlawful or negligent;
 - e. defects arising from the use of non-genuine UTC parts or accessories, or the use of materials not approved for use by UTC;
 - f. any modifications to or installations performed on the OMD's and/or OMD system outside the scope of normal routine maintenance or running repairs without the express prior written approval of UTC;
 - g. deterioration, staining or corrosion of parts which will occur due to normal exposure and usage;
 - h. alleged defects not materially affecting the quality or proper functioning of the OMD system.

5. In addition the Warranties shall be limited as follows:
 - a. UTC shall be under no liability in respect of any defect in the OMD's and/or OMD System arising from any drawing, design or specification supplied by or at the request of the buyer or system owner (not being a drawing, design or specification of UTC);
 - b. UTC shall be under no liability in respect of any defect or failure of the OMD's and/or OMD System to operate in accordance with specifications, illustrations, descriptions or other particulars due to their combination or use with any incompatible equipment or product.

6. The Warranties are conditional upon:
 - a. the buyer or OMD system owner giving written notice to UTC of the alleged defect, such notice to be given immediately when the buyer or OMD system owner discovers or ought to have discovered the defect;
 - b. the buyer or OMD system owner affording UTC a reasonable opportunity to inspect the OMD's and/or OMD system;
 - c. the buyer or OMD system owner not altering or attempting to repair the OMD's and/or OMD system without the written consent of UTC.
7. The Warranties can be transferred to any new owner of the OMD system provided UTC is informed in writing within 30 days of the transfer. The OMD System Warranty cannot be transferred to another UTC OMD system.
8. Save to the extent amended by the provisions set out above, UTC's standard terms and conditions of sale shall apply.

* Commissioning is to be performed by a UTC approved service agent.

OMD Service Life

Oil Mist Detectors (OMD's) are an integral part of critical safety systems designed to detect certain conditions that could lead to crankcase explosions on large Diesel engines. They are typically installed in harsh operating conditions - particularly with respect to temperature and vibration - and are expected to provide continuous service over extended periods. They are therefore subject to considerable wear and tear.

In order to ensure reliable performance, it is particularly important that OMD's are properly installed, operated and maintained in accordance with the manufacturer's instructions and guidelines. Given that they are components within key safety systems, as precautionary advice the manufacturer recommends replacing or refurbishing OMD's which are more than 10 years old, even if they are functioning correctly at that time.

1 DESCRIPTION AND OPERATION

1.1 INTRODUCTION

High temperatures, in excess of 200°C that occur on bearing surfaces under initial failure conditions, can lead to a rapid generation of oil vapour. When the hot vapour contacts the relatively cooler atmosphere of the crankcase it condenses into a fine mist, with typical particle sizes of around 0.5 to 5 microns in diameter. When the density of these particles reaches between 30 to 50 mg/l (Milligrams per litre), depending upon the type of oil, an explosive condition exists.

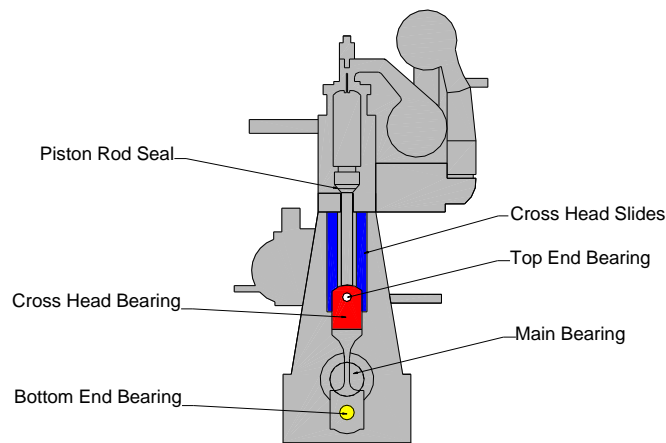


Figure 1 Areas of Failure – 2 Stroke Engine

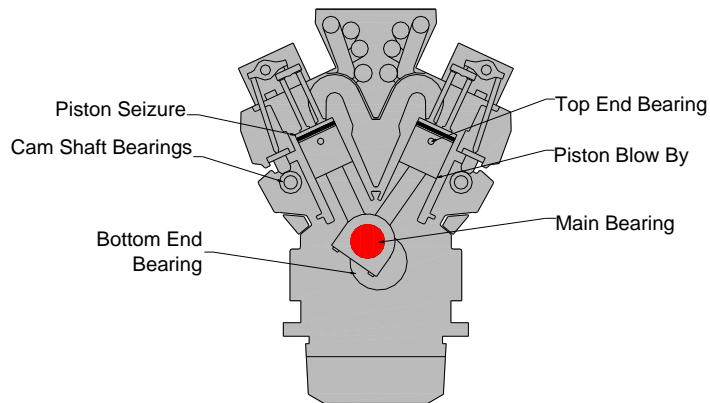


Figure 2 Areas of Failure – 4 Stroke Engine

A fire or explosion needs three constituents: fuel, oxygen and an ignition source. Remove one of these and no explosion will occur. Similarly, within the crankcase, the three constituents which could cause an explosion are air, oil mist and an ignition source, the "hot spot". Using optical measuring techniques, oil mist density can be measured at levels as low as 0.05 mg/l and give early warning of a rise in oil mist density.

Oil Mist Detection (OMD) techniques have been used to monitor diesel engine crankcases for potential explosive conditions and early detection of bearing failures. The systems available rely mainly on analysing the optical density of oil mist samples drawn from the crankcase compartments, through pipes to the detector. While these systems proved successful in the past, engine design has improved significantly over the years and oil mist detection techniques have improved substantially to maintain adequate protection.

The Graviner Mk 7 OMD provides the following benefits:

- Auto addressed system monitoring up to 10 detector heads per control unit
- Up to 10 control units per single system.
- Suitable for both 2 stroke and 4 stroke engines.
- Elimination of sample pipes - reduced installation costs.
- Engine mounted Control Unit.
- Remote Display Unit mounted in a safe area, typically the Engine Control Room (ECR).

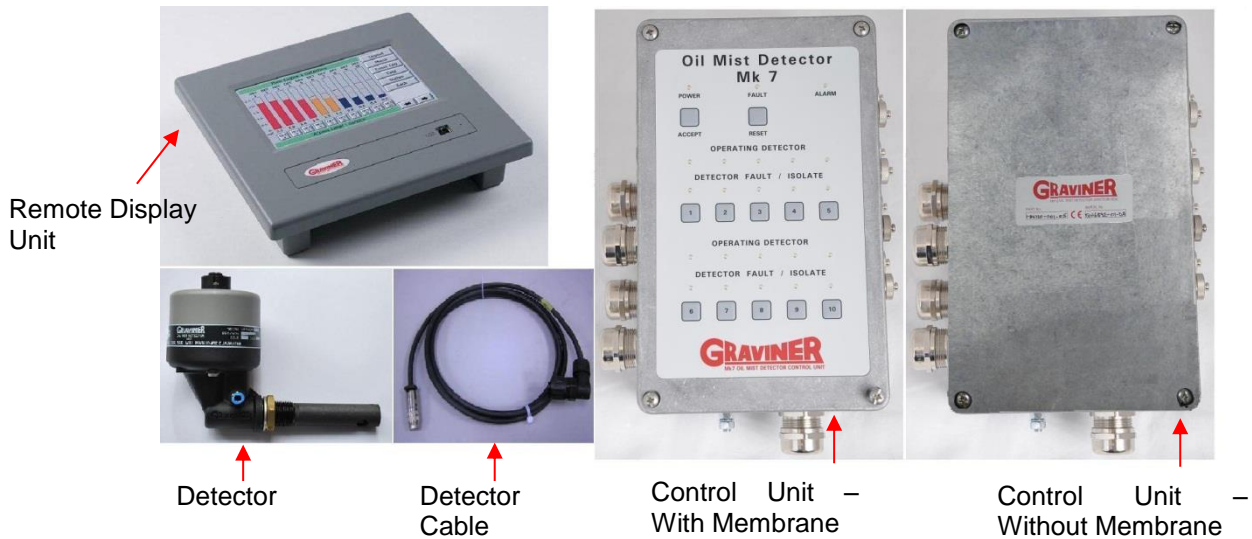


Figure 3 Graviner Mk7 OMD Components

1.2 DESCRIPTION

The system comprises three main components (refer to Figure 3):

Detectors	1-53836-K269 (with base) / 1-53836-K272 (replacement detector head)
	1-53836-K269-01 (Short sample pipe)
Control Unit	1-53836-K270 (With Membrane) 1-53836-K276 (Without Membrane)
Remote Display Unit	1-53836-K271

And connecting cables

Control Unit to Detector cable (Straight)	1-43682-K286-XX
Control Unit to Detector cable (Right Angle)	1-43682-K285-XX

The Graviner Mk 7 OMD system can comprise up to 100 detectors directly mounted on the crankcases of up to 10 engines, allowing both main propulsion and auxiliary generators to be monitored at the same time.

Each detector communicates electronically over a serial data link via the engine mounted Control Unit with the Remote Display Unit designed to be mounted within the Engine Control Room. This eliminates the need to enter the machinery space in alarm conditions.

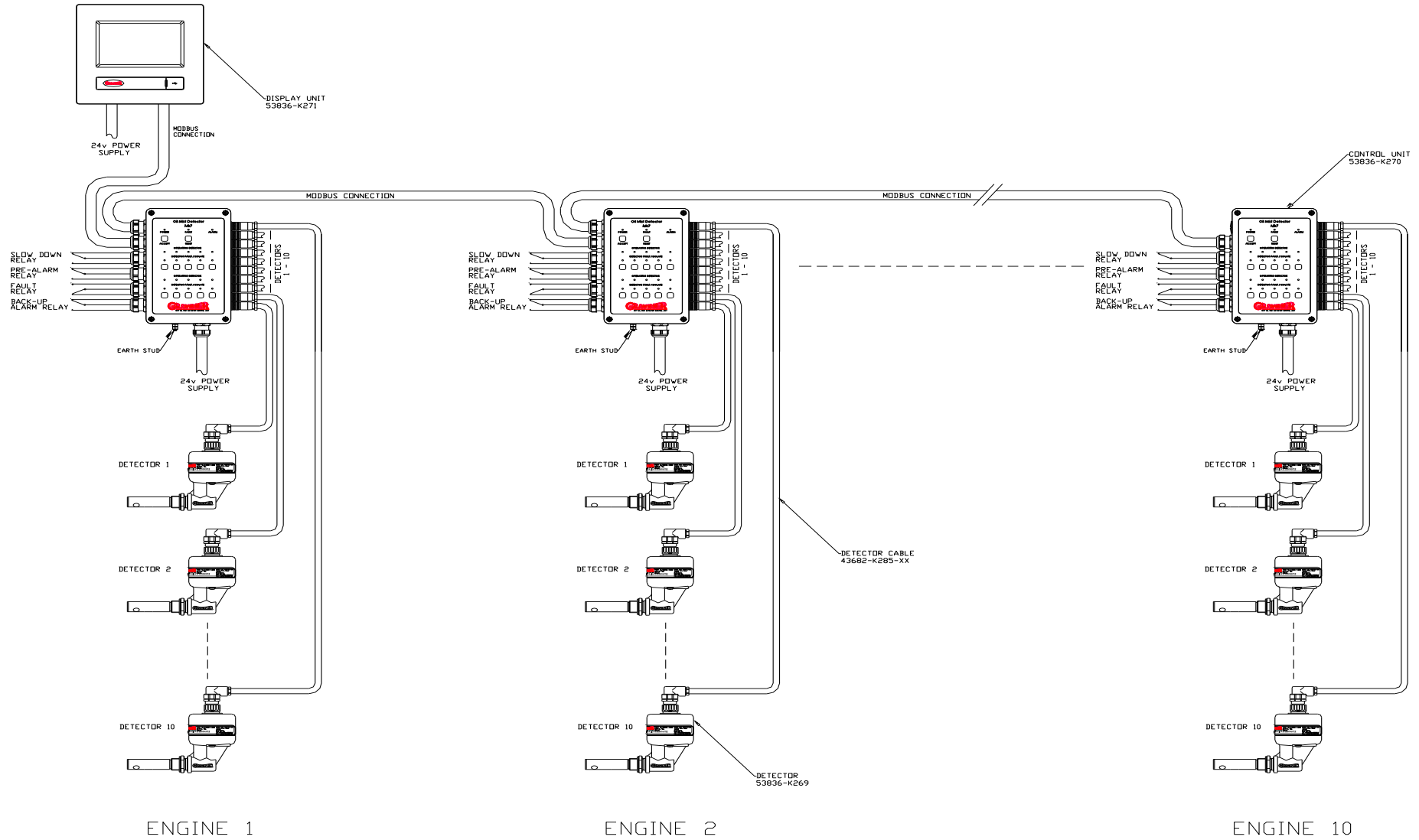


Figure 4 Typical System Configuration – With Membrane

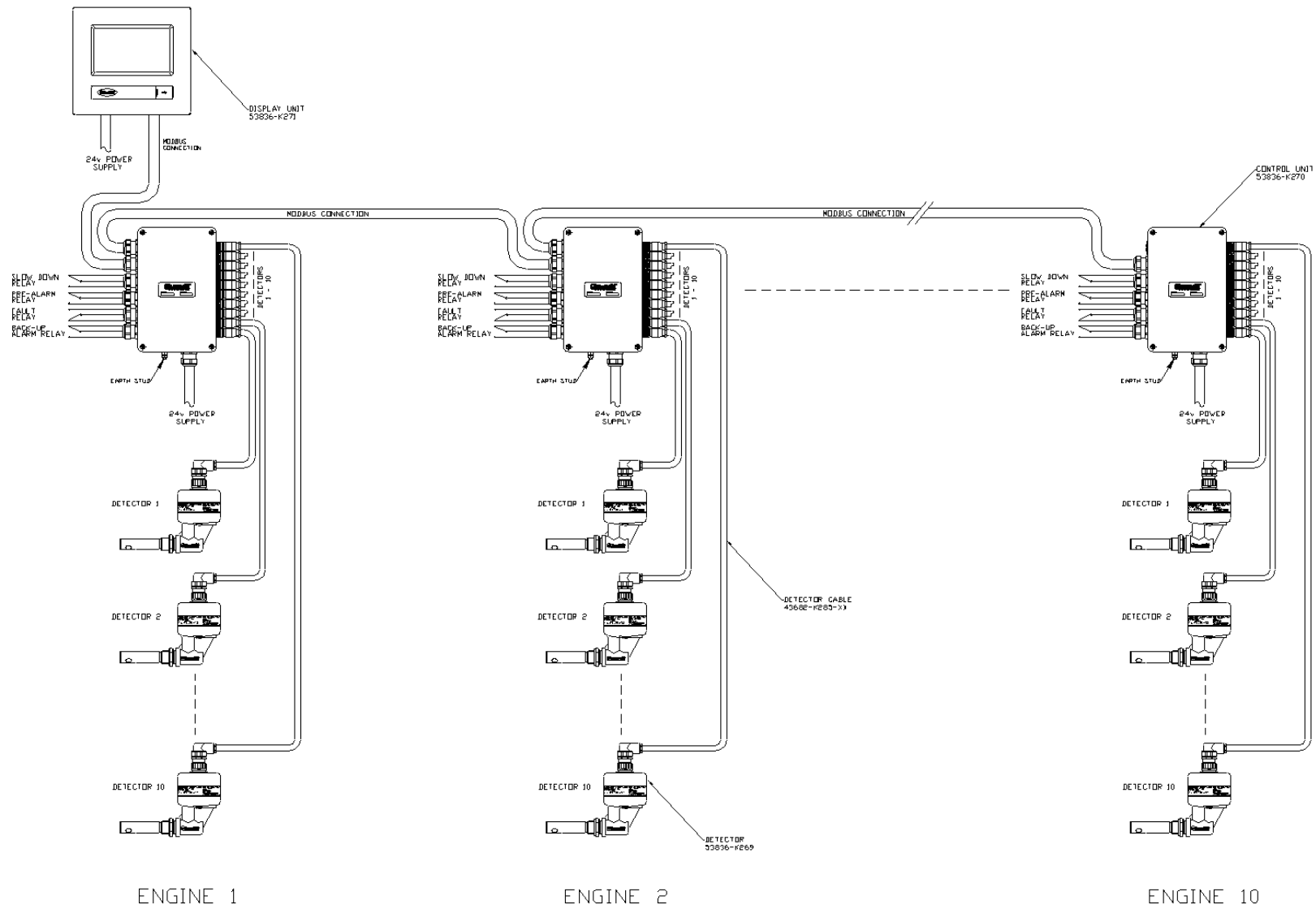


Figure 5 Typical System Configuration – Without Membrane

1.3 TECHNICAL SPECIFICATION

Detector

Mounting	¾ inch BSP
Enclosure Rating	IP65
Material	Sample Tube – Carbon Loaded PTFE Detector – Black Du Pont Nylon 70G33L
Indicators	Green Detector On
Red	Alarm
Amber	Detector Fault
Power Consumption	1.5W
Temperature Rating	0 – 70°C
Height	153mm
Width	90mm
Length	205mm
Weight	0.5kg

Control Unit

Enclosure Rating	IP65
Material	Aluminium
Max detector inputs	10

Output Relays	Volt-free change over contacts rated at 30Vdc 1A Relay contact minimum wetting current = 10mA
Pre Alarm	1 set (de-energised during normal operation)
Fault Alarm	1 set (energised during normal operation)
Engine Slow/Shutdown Alarm	1 set (de-energised during normal operation)
Back-up Alarm	1 set (de-energised during normal operation)

Alarm Ranges

Pre Alarm	0.5mg/l to 1.2mg/l (adjustable) (Default 0.9mg/l)
Engine Slow/Shutdown Alarm	1.3mg/l to 2.4mg/l (adjustable) (Default 1.8mg/l)
Back-up Alarm	3.0mg/l (fixed)

Operating Voltage	24Vdc (+30% -25%)
Power Consumption	3.9W
Temperature Rating	0 – 70°C
Dimensions	
Height	186mm (110mm mounting centres)
Width	318mm (240mm mounting centres)
Depth	90mm
Weight	2.8kg

Remote Display Unit

Enclosure Rating	IP32	
Material	ABS (PA-765+)	
Max No. of detectors	100	
Max No. of engines monitored	10	
Power Supply	24Vdc (+30% -25%)	
Power Consumption	6.0W	
Temp Rating	0 – 70°C	
Humidity level	95%	
Dimensions		
Bulkhead Mounted:	Height	225mm (202mm mounting centres)
	Width	240mm (217mm mounting centres)
	Depth	58mm
Panel Mounted:	Height	225mm (202mm mounting centres)
	Width	240mm (217mm mounting centres)
	Depth	55mm
Weight	1.0kg	

1.4 SYSTEM OVERVIEW

The Graviner Mk7 OMD is an auto addressed oil mist detection system capable of monitoring up to 10 Control Units per system with each Control Unit having up to 10 detectors connected to it. This is achieved without external sample pipes and with minimum cabling. Each detector head monitors a single crank space and is a stand-alone device. On power up the detectors gather oil mist density data and convert it to a digital signal for transmission via the data lines in the detector cable to the Control Unit which is also mounted on the side of the engine. Alarm levels and Alarm output requirements are all set from either the Remote Indicator Display or a PC connected directly to the control unit.

The Remote Display Unit houses a 7.5" LCD Touch Screen display that shows, on demand, the signal from each detector and indicates the oil mist level for each engine and when required each detector as well as the status of the system. In the event of an alarm, the display immediately shows the oil mist levels for the relevant engine. It also enables the individual readings of each detector on the engine to be displayed on demand and automatically under alarm conditions.

In the event of a detector fault, that detector can be isolated without affecting the function of the other detectors on the engine. The system will continue to operate while the faulty detector is replaced, repaired or maintenance is carried out.

The Mk7 detectors still use optical sensing; (light scatter) as it's detection method and continually monitors the oil mist density in the crank space to which it is connected. In addition, it self-checks for any internal faults. The Control Unit interrogates each detector in turn, identifies the position connected at the Control Unit, the oil mist density value and determines the status of the detector.

Each detector is fitted with 3 LED indicator lights:

Green	-	Power on
Red	-	Alarm
Amber	-	Fault

As all detectors operate independently, the loss of one detector through a fault does not affect the operation of the rest of the system. Individual detectors, or engine groups, can be isolated from the rest of the system for maintenance while the rest of the system remains in operation.

The Control Unit can be supplied with or without a control membrane. The control membrane has LED indication for detectors connected, push buttons for isolation and de-isolation of detectors, as well as pushbuttons for Accepting and Resetting Alarms.

Alarm Philosophy

The system has 3 separate alarm levels as detailed below

1. **Pre Alarm**- This indicates that the oil mist levels are increasing in a particular crank space and that investigation should be undertaken. This alarm will not operate the slowdown/shutdown relays.
2. **Engine Slow/Shutdown Alarm** - When any detector reaches this threshold then the slowdown/shutdown relay will be operated if they are connected.
3. **Back Up Alarm** - In the event of a failure of either the Pre Alarm or High Alarm, then the Back Up Alarm will operate, but it will not operate the slowdown/shutdown relay. This is an additional functional precaution added by UTC Fire & Security UK Ltd which can be connected in any way the customer requires. This is usually connected to a warning beacon or siren; however the customer may choose to connect the relay to another device or the engine slowdown or shutdown circuitry.

On receipt of either a Pre Alarm or High Alarm the engine should, unless connected to a slowdown/shutdown relay, be stopped if safe to do so and allowed to cool down so that the background oil mist levels reduce before entering the engine room.

When the oil mist levels have returned to normal then the Accept and Reset buttons can be operated from the Control Unit membrane if fitted or alternatively from the Remote Display Unit and the system will then return to normal operation.

Fault Diagnosis

When a system fault is received, the information on the display should be noted and then the appropriate Fault Finding procedure in Chapter 4 of the manual should be checked to enable the fault to be rectified.

When the faults have been rectified the Accept and Reset buttons can be operated and the system will return to normal

Event Log

All alarms, faults and events are recorded in an Event Log which is date and time stamped and will indicate the type of event which enables analysis of the events at a later time. The Event Log has a capacity of 1024 events and is a rolling buffer.

SYSTEM CONTROLS AND DISPLAYS

The Remote Display Unit and PC software is menu driven and provides a logical route to all functions. It has three operating levels:

User
Engineer
Service

The User level is essentially for read only interrogation and does not allow any adjustments to be made to alarm settings or system configuration.

The Engineer level is password protected and allows access to most functions and the full range of programmable settings

When selected, a prompt for a password will appear, Enter 012345, when programming is completed the Password should be changed by an authorised person to prevent unauthorised access in the future. This process can be followed in Chapter 2.9 of this manual

The Service level is also password protected (different from the Engineer Menu) and allows access to all functions. This is only available to authorised Kidde Fire Protection personnel and authorised service agents.

Relay Description	Unit off	Unit on	Pre-Alarm	Slowdown/Shutdown	Back-up Alarm	Fault
Pre-Alarm						
Engine Slow/Shutdown Alarm						
Back-up-alarm						
Fault						

Figure 6 Relay Function Modes

2 INSTALLATION AND COMMISSIONING

OMD Mk7 Installation

2.1 CONTROL UNIT MOUNTING

The Control Unit 1-53836-K270 (1-53836-K270-01 Caterpillar only) or 1-53836-K276 is designed for on-engine mounting and it is recommended that the Control Unit is installed as near to the centre of the engine as possible to minimise detector cable lengths.

Mounting is via the four M6 locating holes in the box. Sufficient space must be left around the Control Unit to allow access to the cable glands and the routing of the cables and to facilitate easy access to all aspects of the Control Unit.

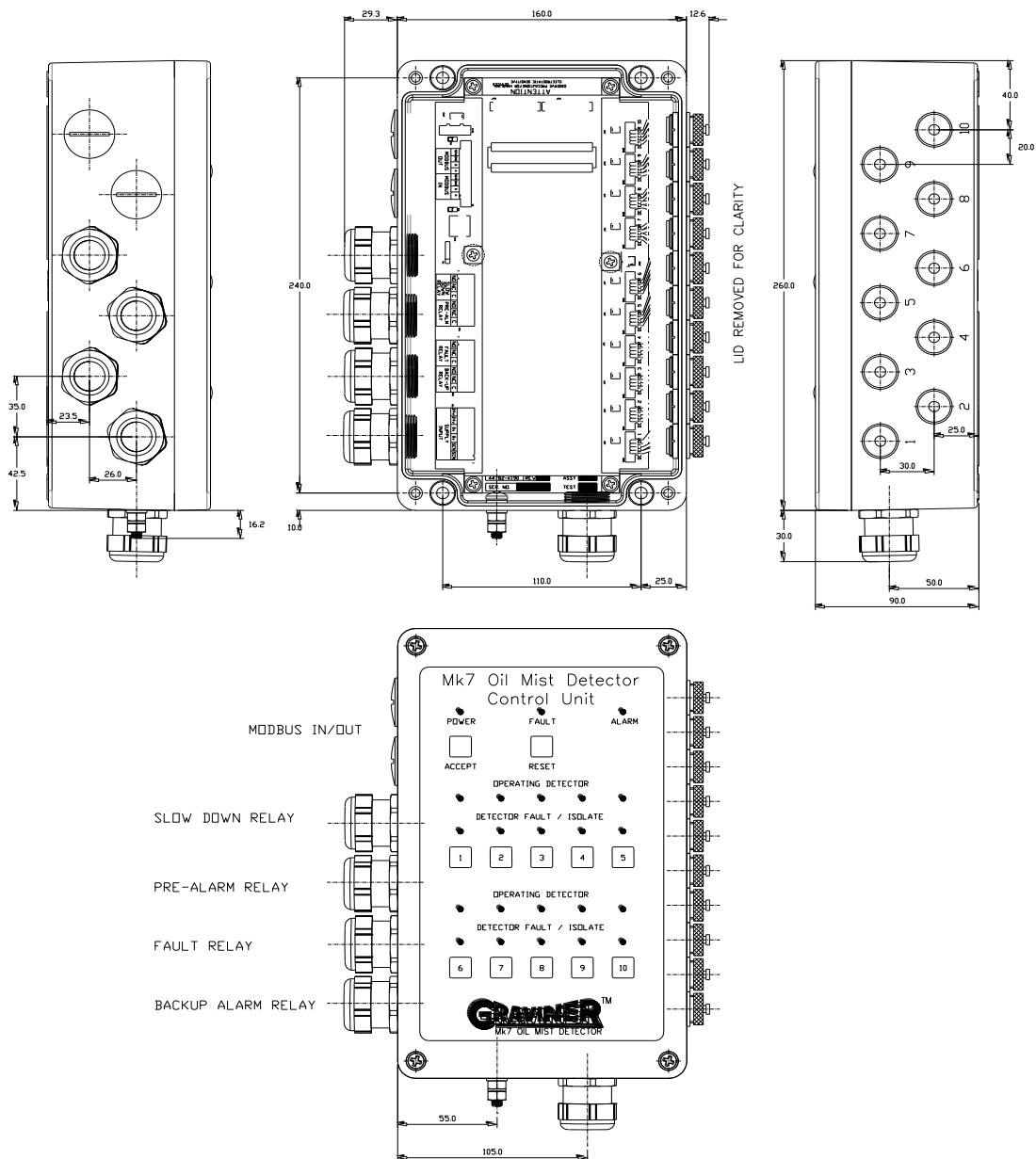


Figure 7 Control Unit 1-53836-K270 (With Membrane)
(Caterpillar 1-53836-K270-01)

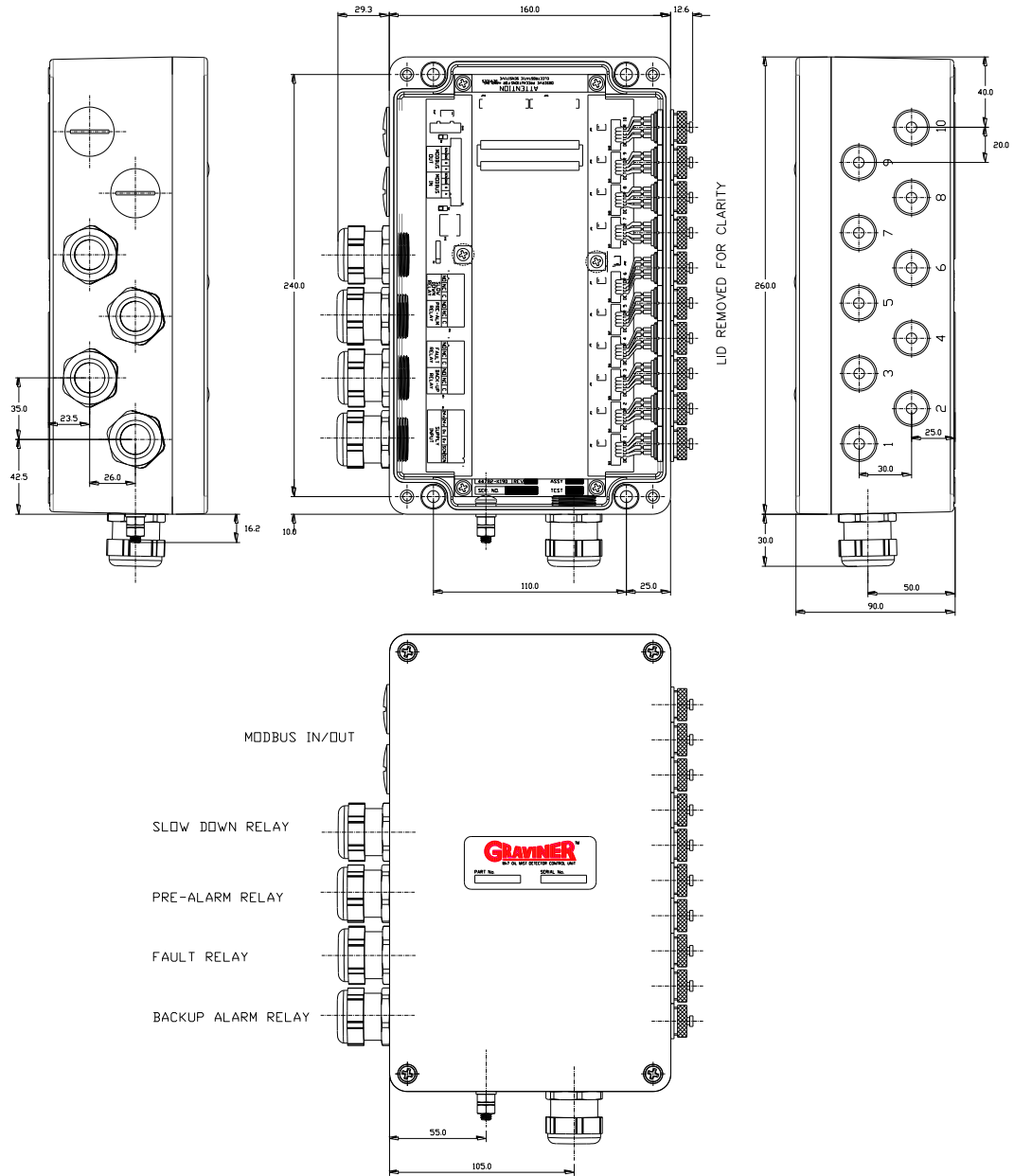


Figure 8 Control Unit 1-53836-K276 (Without Membrane)

2.2 DETECTOR MOUNTING

Each detector is mounted to an individual crankcase via a $\frac{3}{4}$ inch BSP threaded hole.

Ensure all detectors fitted to the engine are locked tightly in place by means of the lock nut supplied.

It is recommended that the detector be located at the upper part of the crankcase wall where it is not in the direct line of the oil throw. On smaller engines it is permissible to mount the detector on the crankcase door if desired or as installation dictates, subject to vibration levels.

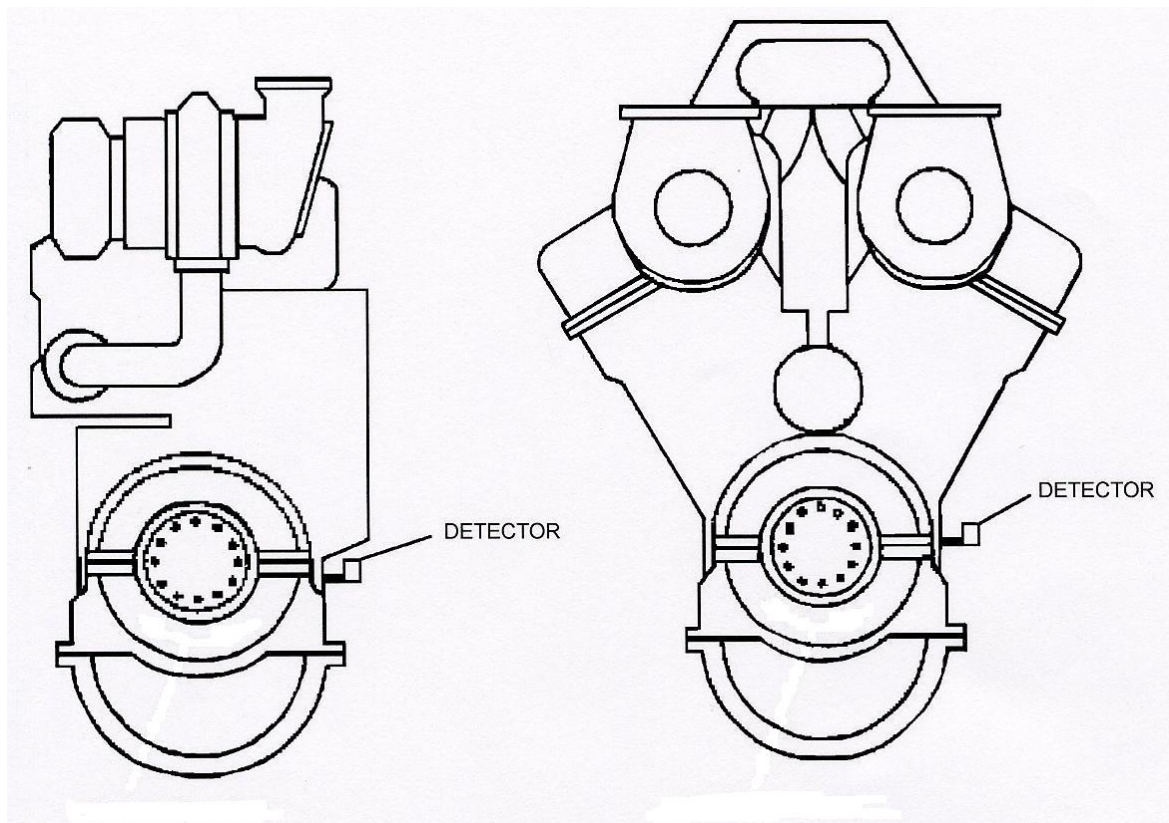


Figure 9 Ideal Mounting Position

The detector must be fitted at a maximum of plus or minus 20 degrees from the vertical. Horizontally the detector must be mounted level or with the detector body inclined towards the engine to ensure oil drainage. Refer to Figure 10, and Figure 11.

Please ensure that Detector 1 is connected to position 1 on the Control Unit, Detector 2 to position 2. Repeat for all Detectors fitted.

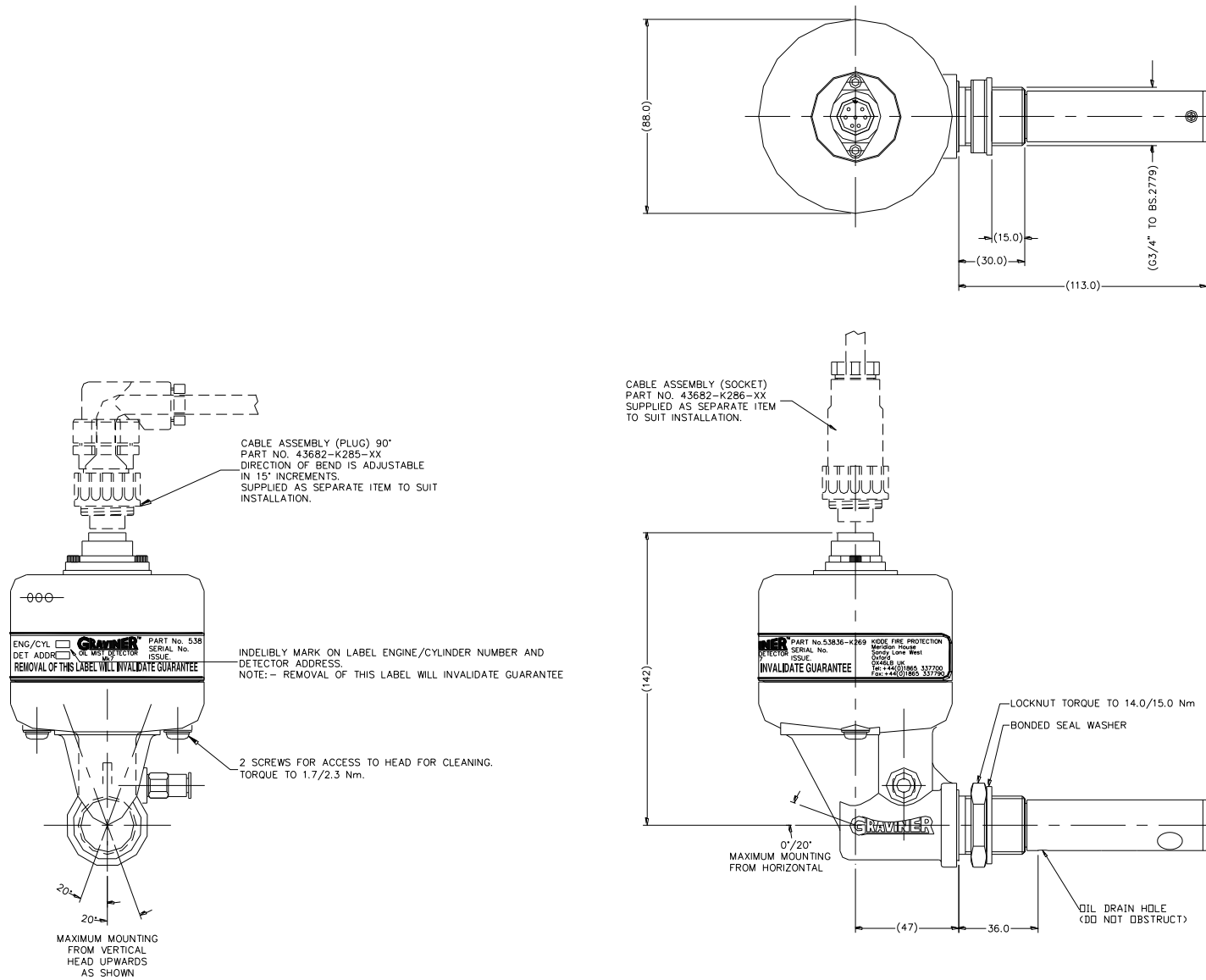


Figure 10 Detector Head Installation

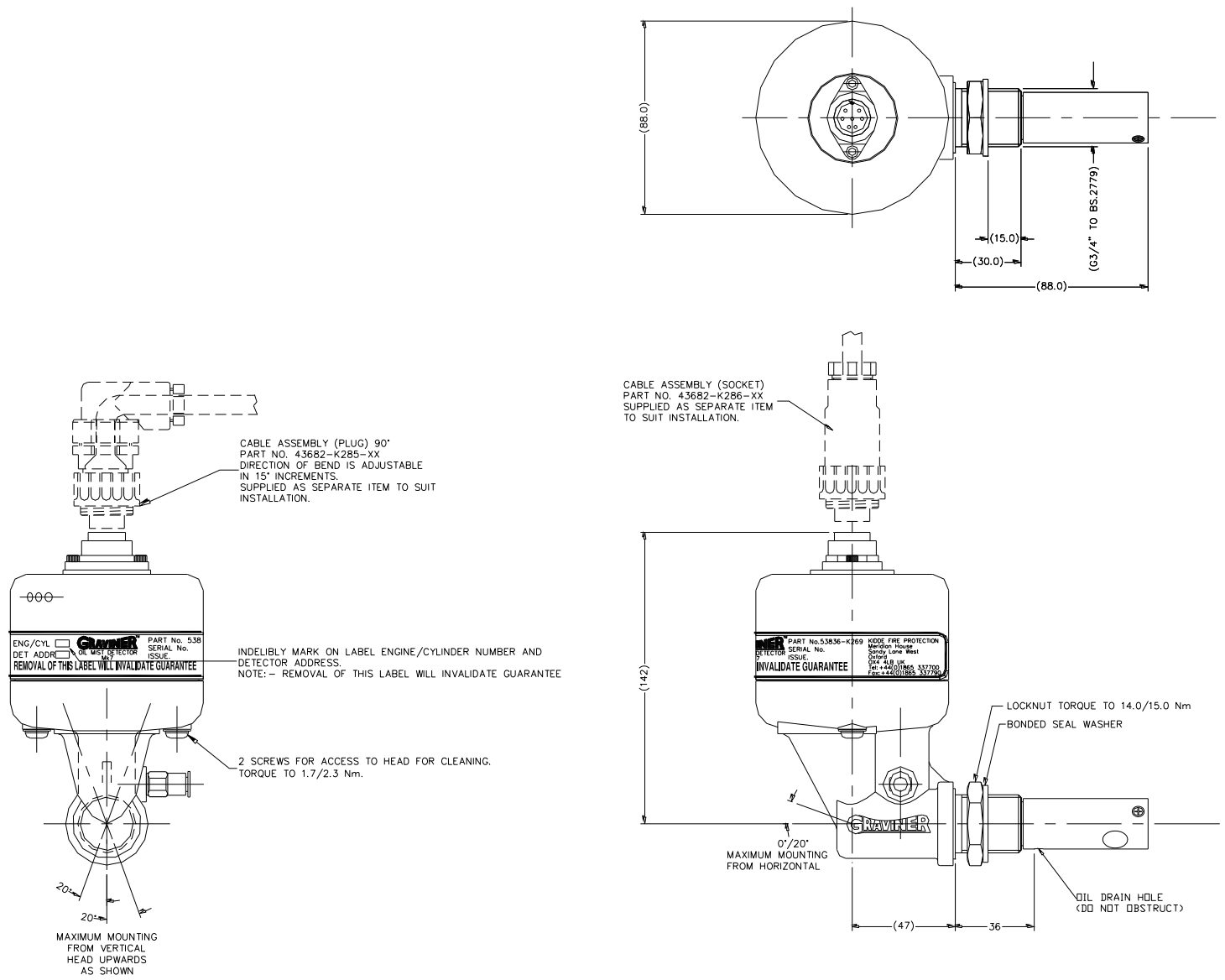


Figure 11 Detector Head Installation (Short Sample Pipe)

2.3 DETECTOR CABLES

Each detector must be connected to the Control Unit by way of a supplied detector cable. Refer Figure 12.

Ensure that the cables are run in a suitable cable tray and clipped at regular intervals to ensure they cannot be subjected to mechanical damage caused by vibration.

Cable Length m	90° Connector Part No.	Straight Connector Part No.
1.0	1-43682-K285-1.0	1-43682-K286-1.0
1.5	1-43682-K285-1.5	1-43682-K286-1.5
2.0	1-43682-K285-2.0	1-43682-K286-2.0
2.5	1-43682-K285-2.5	1-43682-K286-2.5
3.0	1-43682-K285-3.0	1-43682-K286-3.0
3.5	1-43682-K285-3.5	1-43682-K286-3.5
4.0	1-43682-K285-4.0	1-43682-K286-4.0
4.5	1-43682-K285-4.5	1-43682-K286-4.5
5.0	1-43682-K285-5.0	1-43682-K286-5.0
5.5	1-43682-K285-5.5	1-43682-K286-5.5
6.0	1-43682-K285-6.0	1-43682-K286-6.0
6.5	1-43682-K285-6.5	1-43682-K286-6.5
7.0	1-43682-K285-7.0	1-43682-K286-7.0
7.5	1-43682-K285-7.5	1-43682-K286-7.5
8.0	1-43682-K285-8.0	1-43682-K286-8.0
8.5	1-43682-K285-8.5	1-43682-K286-8.5
9.0	1-43682-K285-9.0	1-43682-K286-9.0
9.5	1-43682-K285-9.5	1-43682-K286-9.5
10.0	1-43682-K285-10.0	1-43682-K286-10.0
10.5	1-43682-K285-10.5	1-43682-K286-10.5
11.0	1-43682-K285-11.0	1-43682-K286-11.0
11.5	1-43682-K285-11.5	1-43682-K286-11.5
12.0	1-43682-K285-12.0	1-43682-K286-12.0
12.5	1-43682-K285-12.5	1-43682-K286-12.5
15.0	1-43682-K285-15.0	1-43682-K286-15.0
17.5	1-43682-K285-17.5	1-43682-K286-17.5
20.0	1-43682-K285-20.0	1-43682-K286-20.0
22.5	1-43682-K285-22.5	1-43682-K286-22.5
25.0	1-43682-K285-25.0	1-43682-K286-25.0



Figure 12 Detector Cable

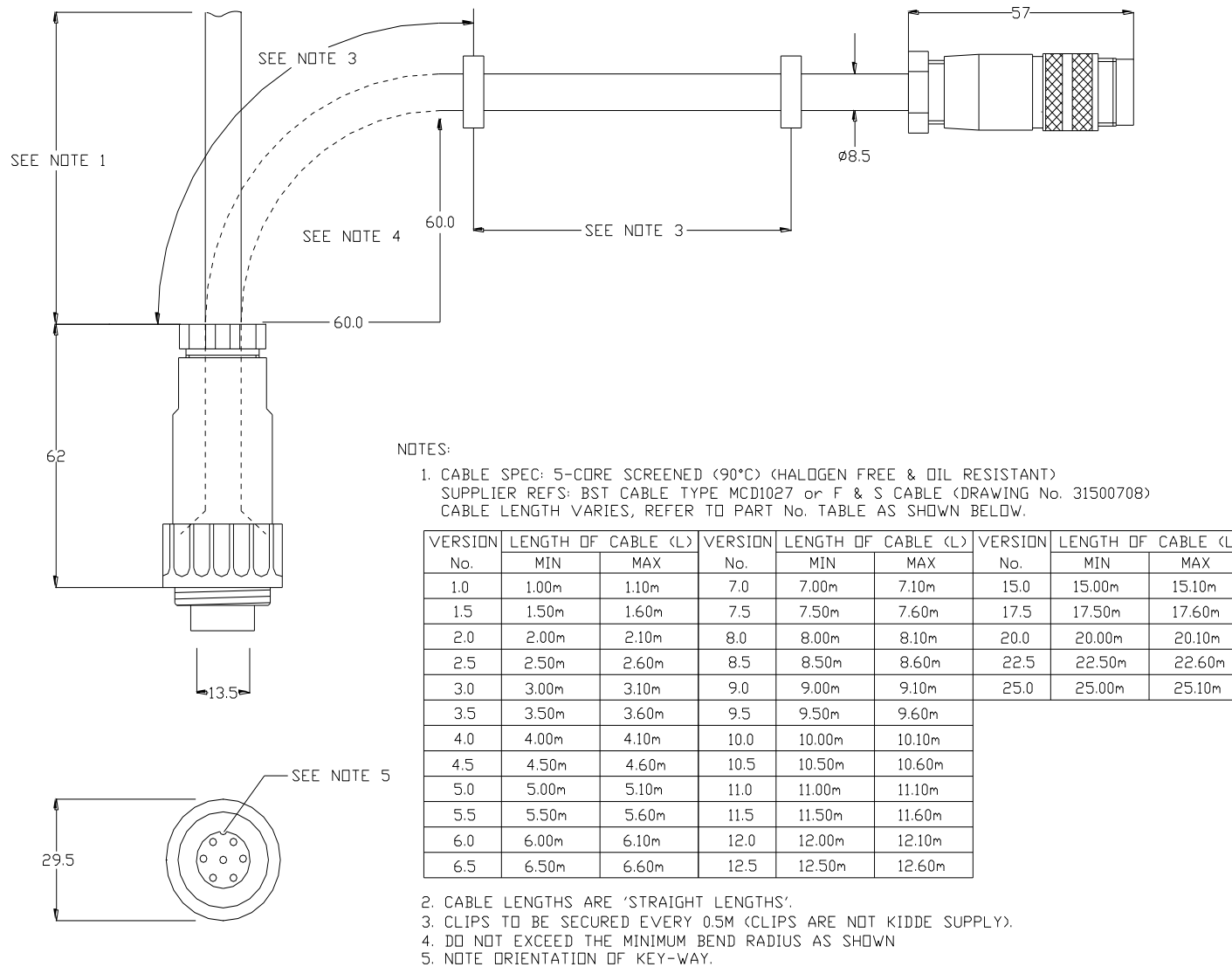
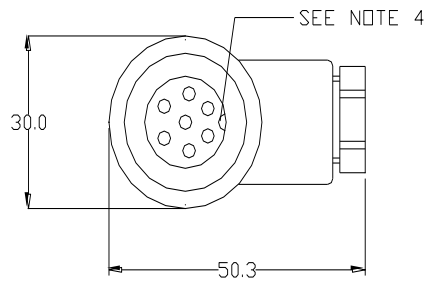
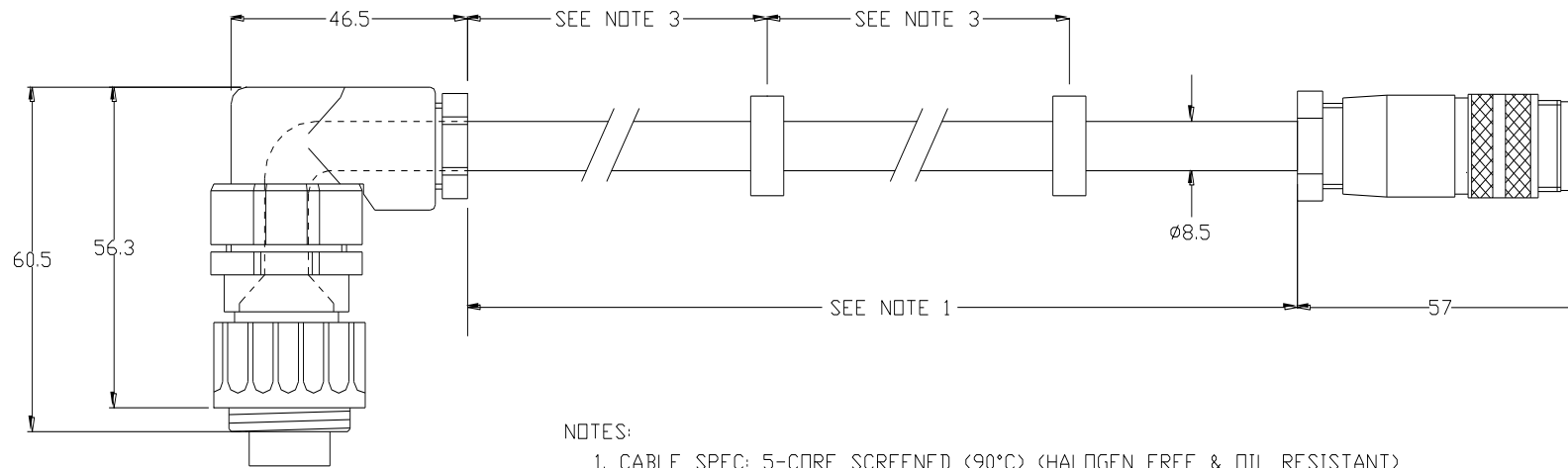


Figure 13 Detector Cable Assembly (Straight Connector)



NOTES:

1. CABLE SPEC: 5-CORE SCREENED (90°C) (HALOGEN FREE & OIL RESISTANT)
 SUPPLIER REFS: BST CABLE DRG NO MCD1027 or F & S CABLE (DRAWING No. 31500708)
 CABLE LENGTH VARIES, REFER TO PART No. TABLE AS SHOWN BELOW.

VERSION No.	LENGTH OF CABLE (L)		VERSION No.	LENGTH OF CABLE (L)		VERSION No.	LENGTH OF CABLE (L)	
	MIN	MAX		MIN	MAX		MIN	MAX
1.0	1.00m	1.10m	7.0	7.00m	7.10m	15.0	15.00m	15.10m
1.5	1.50m	1.60m	7.5	7.50m	7.60m	17.5	17.50m	17.60m
2.0	2.00m	2.10m	8.0	8.00m	8.10m	20.0	20.00m	20.10m
2.5	2.50m	2.60m	8.5	8.50m	8.60m	22.5	22.50m	22.60m
3.0	3.00m	3.10m	9.0	9.00m	9.10m	25.0	25.00m	25.10m
3.5	3.50m	3.60m	9.5	9.50m	9.60m			
4.0	4.00m	4.10m	10.0	10.00m	10.10m			
4.5	4.50m	4.60m	10.5	10.50m	10.60m			
5.0	5.00m	5.10m	11.0	11.00m	11.10m			
5.5	5.50m	5.60m	11.5	11.50m	11.60m			
6.0	6.00m	6.10m	12.0	12.00m	12.10m			
6.5	6.50m	6.60m	12.5	12.50m	12.60m			

2. CABLE LENGTHS ARE 'STRAIGHT LENGTHS'.
3. CLIPS TO BE SECURED EVERY 0.5M (CLIPS ARE NOT KIDDE SUPPLY).
4. NOTE ORIENTATION OF KEY-WAY.

Figure 14 Detector Cable Assembly (Right Angle Connector)

2.4 REMOTE DISPLAY UNIT

The Remote Display Unit part number 1-53836-K271 must be mounted in the Engine Control Room (ECR) or similar safe environment, do not mount in an Engine Room as it is not designed to be mounted in this type of environment. Additionally Class Society rules state that any display must be mounted in a safe area away from the Engine Room.

For flush mounting details see below and Figure 15 and Figure 16.

For bulk head mounting details see Figure 17.

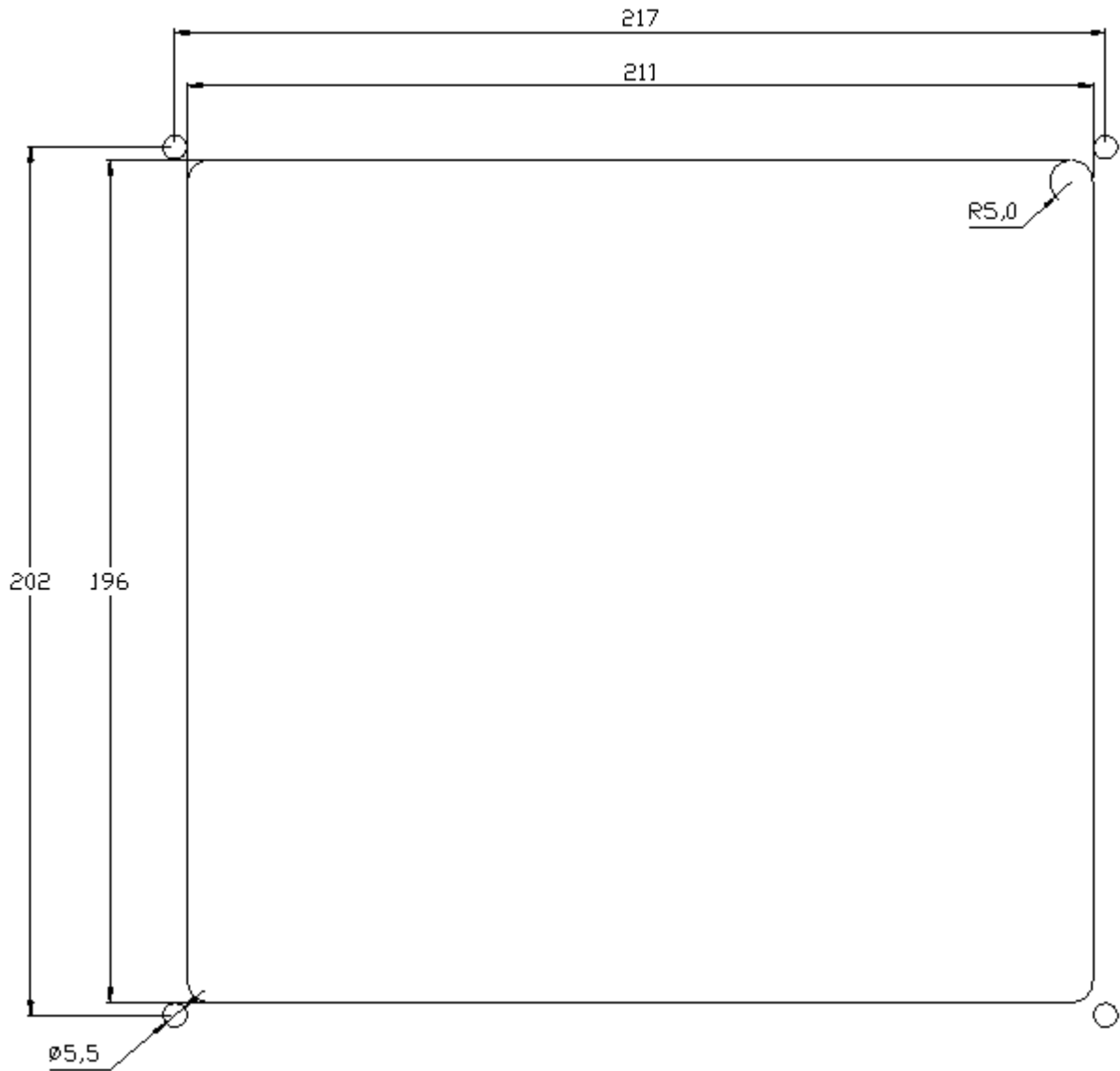


Figure 15 Flush Mounting Cut-out for Remote Display Unit

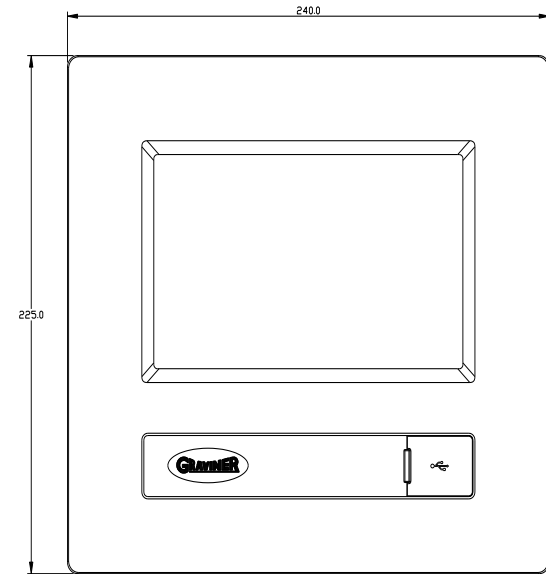
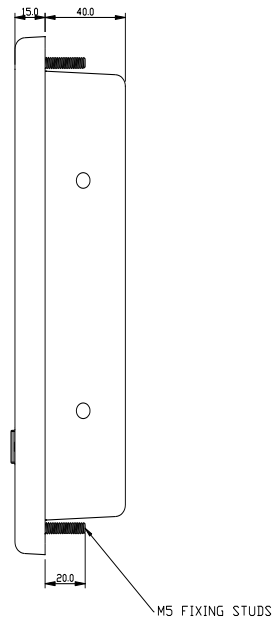
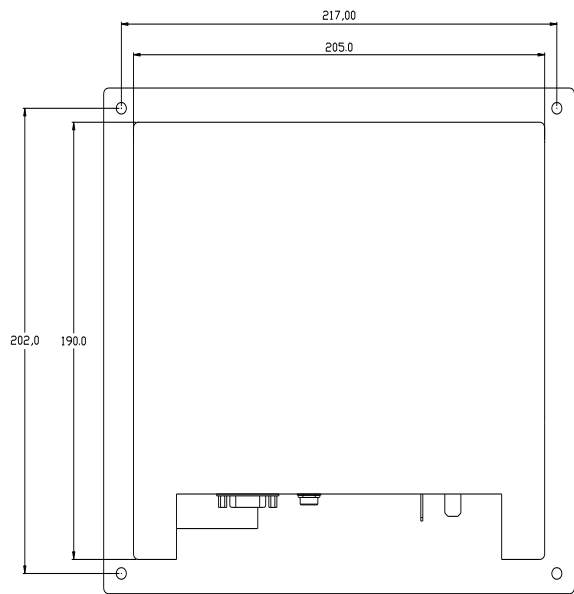


Figure 16 Flush Mounting for Remote Display Unit

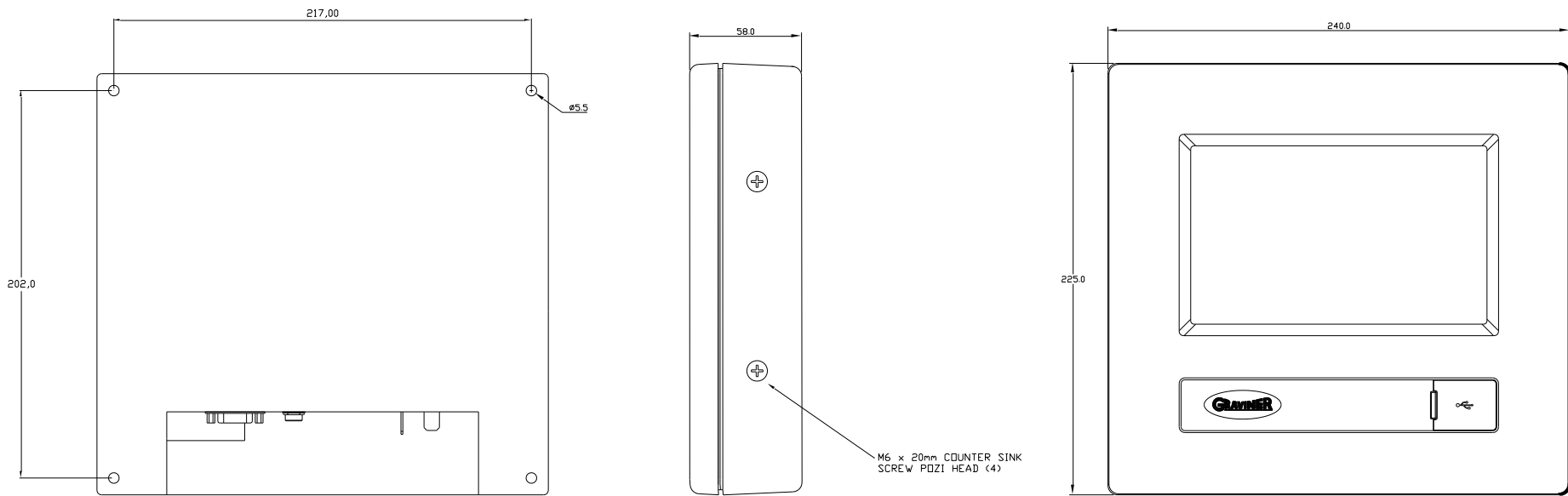


Figure 17 Bulk Head Mounting for Remote Display Unit

2.5 CONTROL UNIT

24v DC Input supply

The Mk7 Control Unit should be powered from a floating 24v DC supply (+30% -25%) rated at 1.0Amp continuous rated, with 2.5Amp surge for 1.5ms.

PLEASE NOTE :- The Control unit(s) may not operate correctly if the external 24v power supply is referenced to the vessel earth and there is also a risk the input protection circuitry in the units could be damaged.

Cables should be segregated from high voltage cables and follow good installation practice

Cable type-2 Cores + Earth, CSA 2.5mm² (50/0.25mm), flexible stranded bare copper conductors, low smoke halogen free insulation, cores laid up, braided screen, low smoke halogen free sheath – grey, outside diameter 9.8mm, operating temperature 0°C + 80°C.

Suggested cables

Lapp Kabel	CY cable 3 core 2.5mm ²
Prysmian	LSM-HF 3 core 2.5mm ²
Helkama	LKAM-HF 3 core 2.5mm ²

Refer Figure 18 for connector location.

Refer Figure 18 for wiring drawing.

Modbus

Cable type – Individually screened 2 pair data cable, 24AWG, low capacitance, low smoke halogen free. Outer diameter 7mm (max)

Cables should be segregated from high voltage cables and follow good installation practice

Suggested cables

FS Cables	2402PIFFH
Beldon	9729
Helkama	RFE-HF(i) 2x2x0.75
Jinro	60V RCOP(IS)

The above cable should be used to connect between the Control Units and either the ships Alarm Management System (AMS) or the Remote Display Unit.

Refer Figure 18 for connector location.

Refer Figure 18 for wiring drawing.

Please Note: The Control Unit Modbus data cable should NOT be connected with the power already applied to the unit.

Relay Outputs

The relay outputs are rated at 30v DC at 1amps.

2 Cores + Earth, CSA 2.5mm² (50/0.25mm), flexible stranded bare copper conductors, low smoke halogen free insulation, cores laid up, braided screen, low smoke halogen free sheath – grey, outside diameter 9.8mm, operating temperature 0°C + 80°C.

Cables should be segregated from high voltage cables and follow good installation practice

Approved cables

Lapp Kabel	CY cable 3 core 2.5mm ²
Prysmian	LSM-HF 3 core 2.5mm ²
Helkama	LKAM-HF 3 core 2.5mm ²

Refer Figure 18 for connector location.
 Refer Figure 18 for wiring drawing.

USB Connection

Refer Figure 18 for connection location.

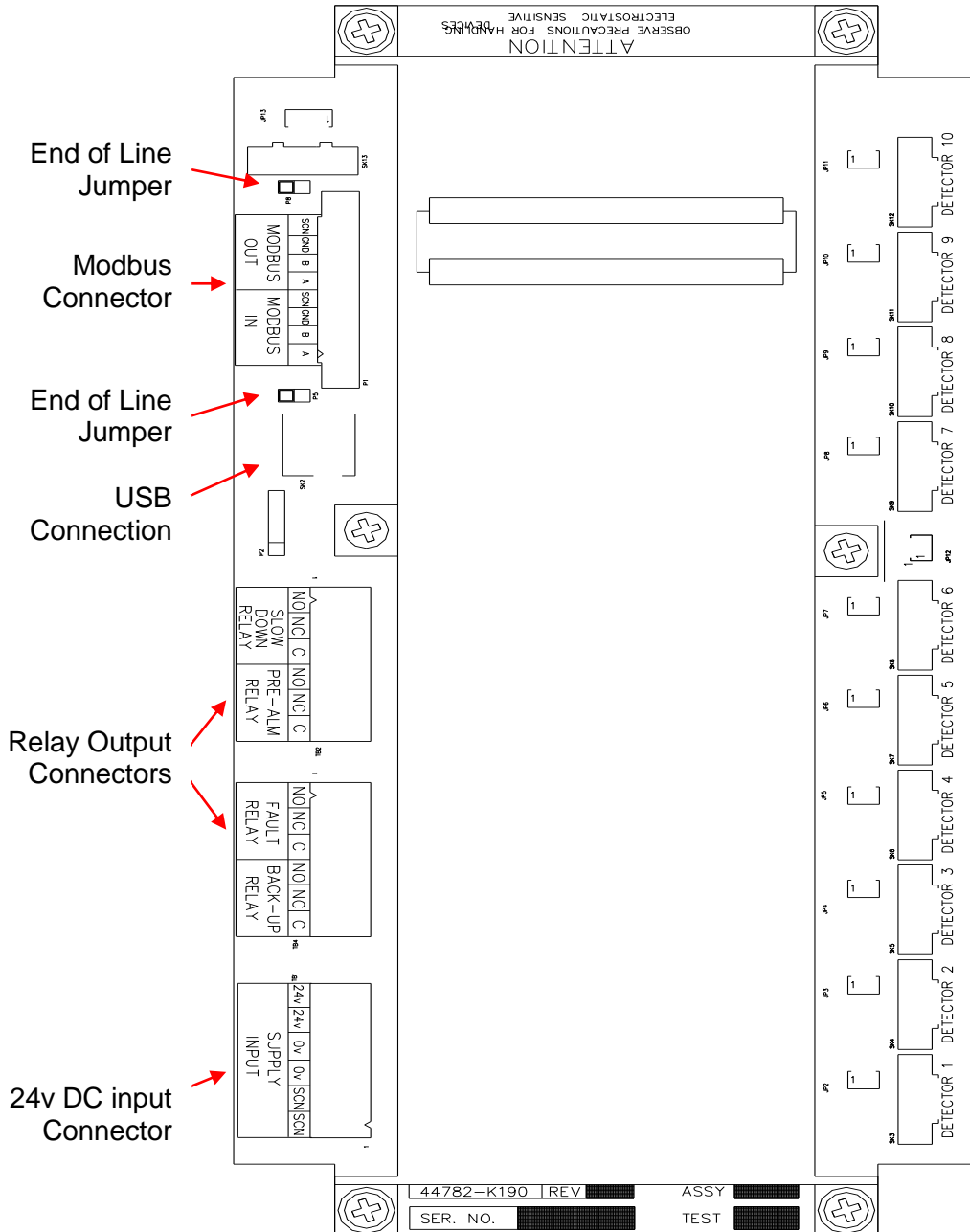


Figure 18 Control Unit PCB

All Detector connectors are prewired.

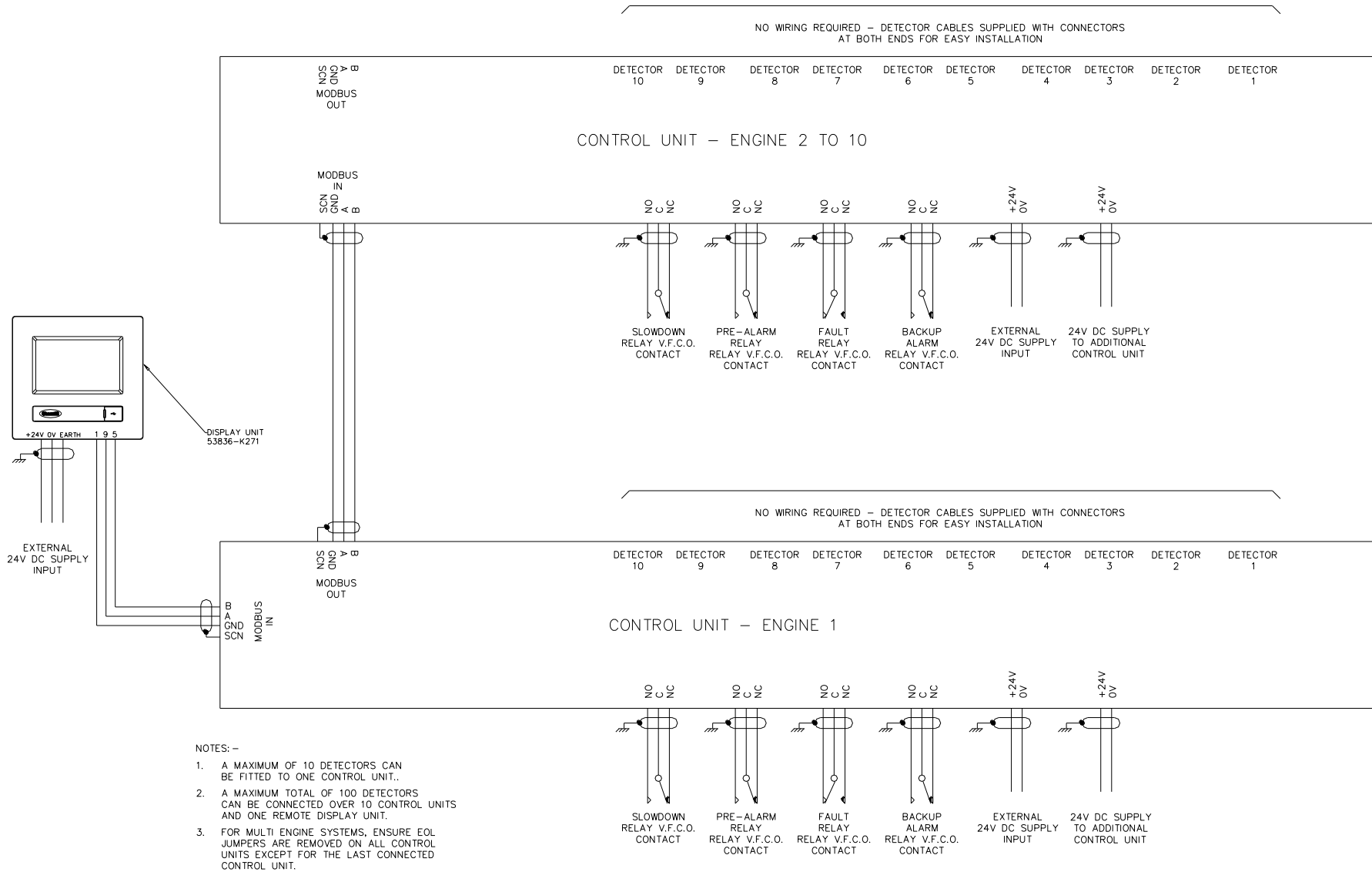


Figure 19 Wiring Drawing

2.6 REMOTE DISPLAY UNIT

24v DC Input supply

The Mk7 Remote Display Unit should be powered from a floating 24v DC supply (+30% -25%) rated at 1.5 Amp continuous rated, with 2.5Amp surge for 1.5ms.

The external supply should be connected via a Hirschmann GM216 NJ power connector.

PLEASE NOTE :- The Remote Display Unit may not operate correctly if the external 24v power supply is referenced to the vessel earth. There is also a risk the input protection circuitry in the unit could be damaged.

Cable type – 2 Cores + Earth, CSA 1.5mm², fine stranded bare copper wires, braided screen, low smoke halogen free sheath, outside diameter 10mm (max), operating temperature 0°C + 80°C.

Cables should be segregated from high voltage cables and follow good installation practice

Suggested cables

Lapp Kabel	1.5mm ² Öflex Classic 110CH - 10035068
Prysmian	LSM-HF 3 core 1.5mm ²
Helkama	LKAM-HF 3 core 1.5mm ²

Refer Figure 20 for 24vDC Socket wiring drawing.
Refer Figure 22 for connection location.

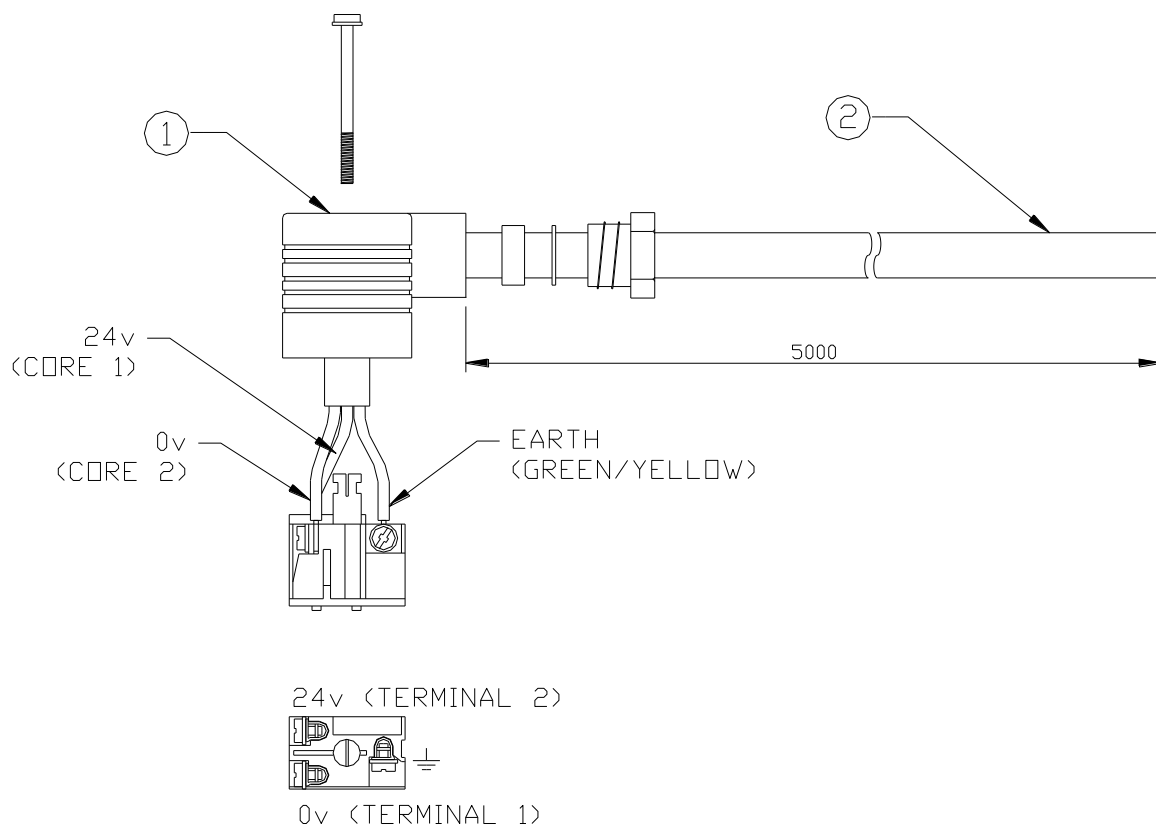


Figure 20 24v DC Socket Wiring Drawing

Modbus

Cable type – Individually screened 2 pair data cable, 24AWG, low capacitance, low smoke halogen free. Outer diameter 7mm (max)

To prevent signal crosstalk OMD cables should be segregated from high voltage cables and follow good installation practice

Please Note: The Remote Display Unit Modbus data cable should NOT be connected with the power already applied to the unit.

Suggested cables

FS Cables	2402PIFFH
Beldon	9729
Helkama	RFE-HF(i) 2x2x0.75
Jinro	60V RCOP(IS)

The above cable should be used to connect between the control unit and either the ships AMS system or the Remote Display Unit

Refer Figure 21 for Modbus Connector Wiring Drawing.

Refer Figure 22 for connector location.

Refer Figure 23 for cable extension methods

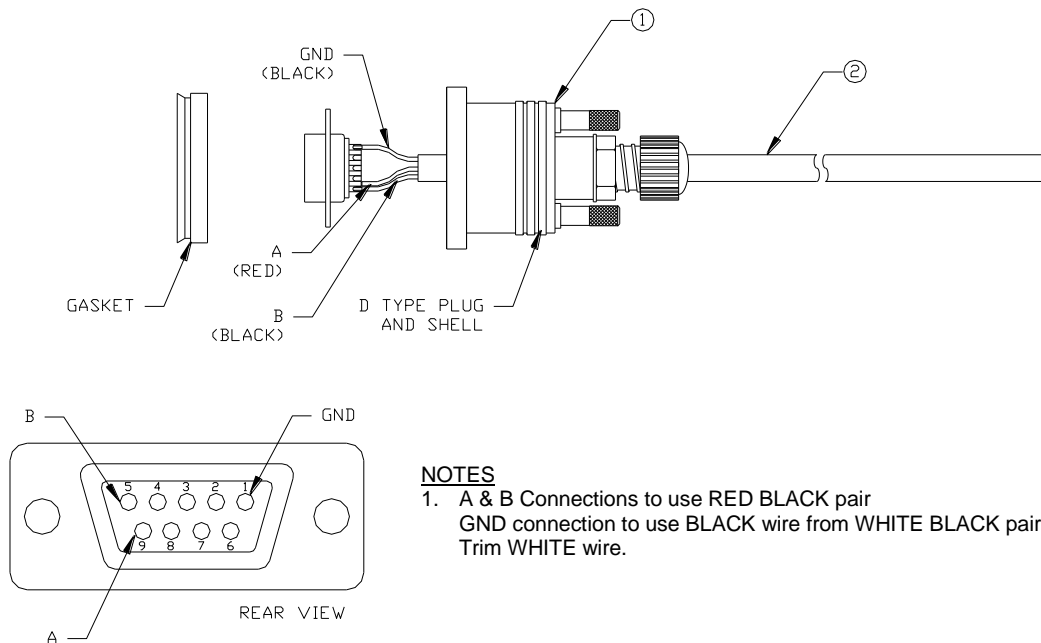


Figure 21 Modbus Connector Wiring Drawing



Figure 22 Remote Display Unit 1-53836-K271

The use of RS485 based signalling allows the RDU and Control unit to be located a large distance apart. The following drawings show the wiring pin out for 3 methods of connecting the extended Modbus cable.

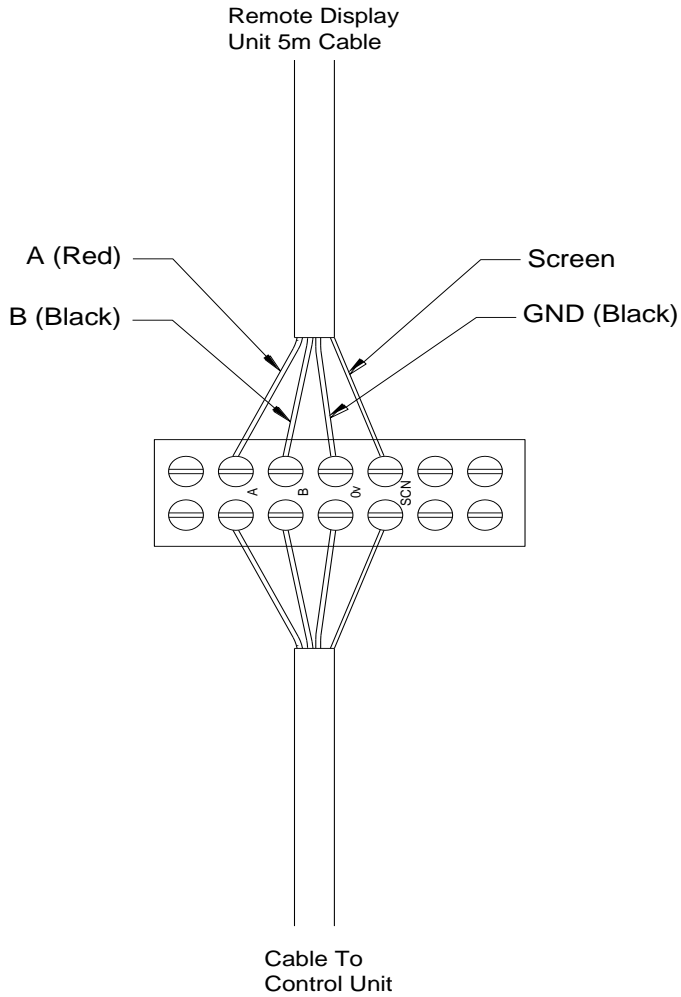


Figure 23 Terminal Block Connection

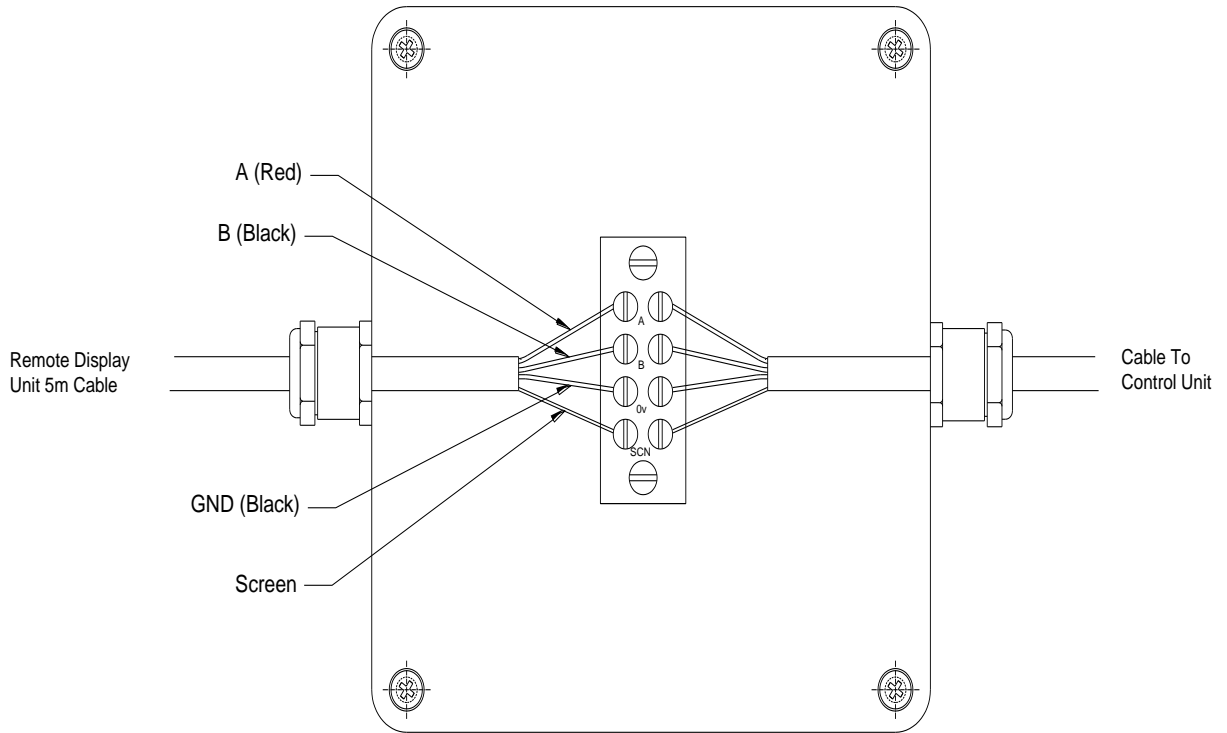


Figure 24 Junction Box Connection

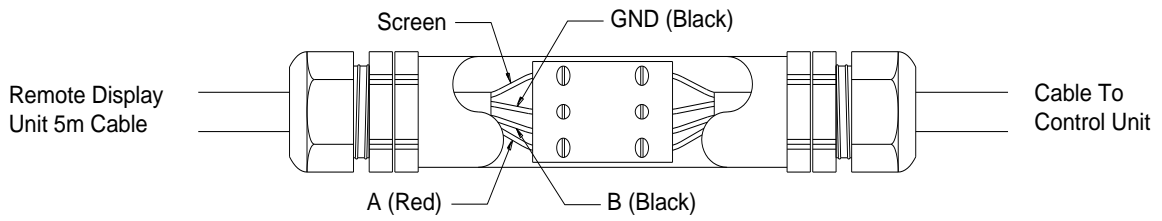


Figure 25 Inline Connector

2.7 CONNECTING THE SYSTEM

2.7.1 Input power

+24 V dc and 0 V dc power input cables for the Control Unit should be terminated onto Supply Input (terminal block TB1).

Cables should be segregated from high voltage cables and follow good installation practice

Note all terminations should be made using crimped wires.

For each of the power connections strip the power cable to the required length to connect to the terminals in the Control Unit. Then remove approximately 1cm of the outer sheath to expose the cable screen as shown below.

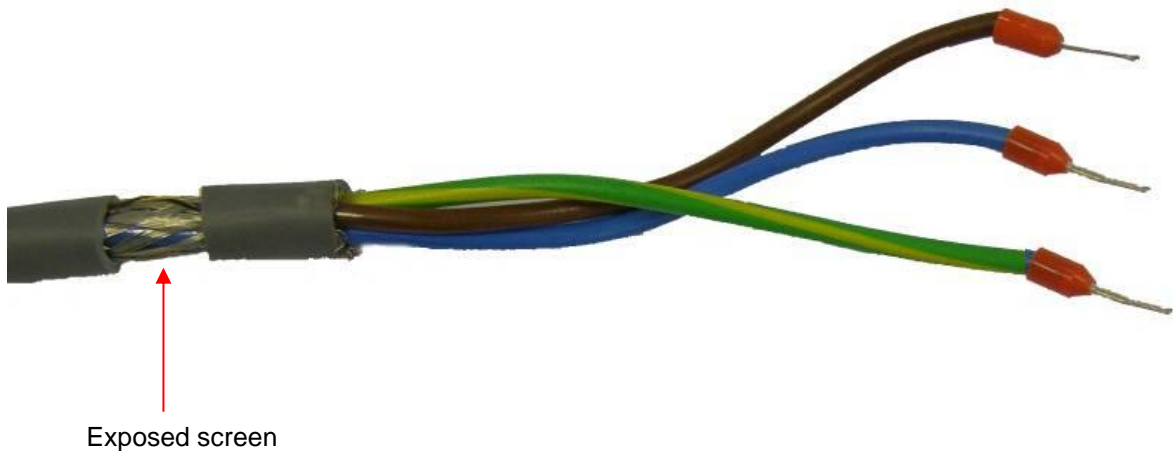


Figure 26 Power cable

Feed the cable into the Control Unit via a metal IP65 EMC gland supplied, ensuring that the metal prongs make contact with the exposed cable screen as shown below.

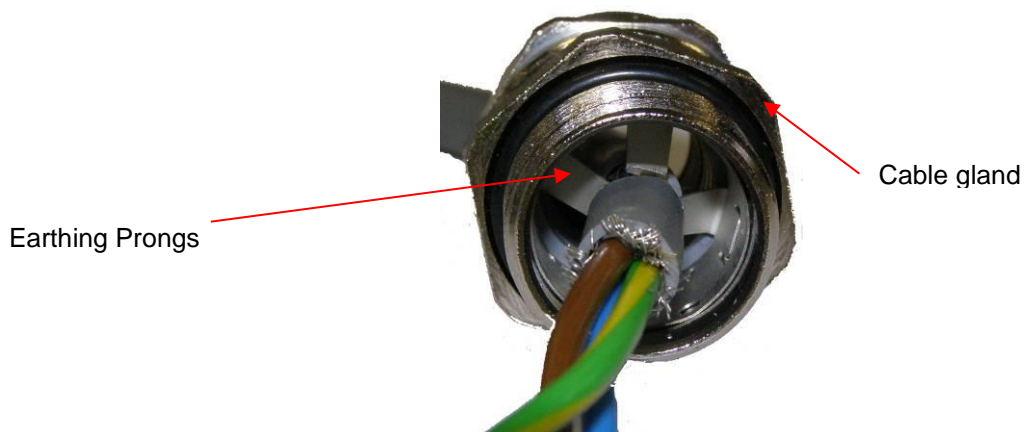


Figure 27 Power cable through EMC gland

2.7.2 Relay Cables

The connection to the Slowdown/Shutdown relay, Pre-Alarm relay, Back-up Alarm relay and Fault relay and 24Vdc supply cables at the Control Unit should be made using screened cable. For each of the relay connection strip the cable to the required length to connect to the terminals in the control unit. Then remove approximately 1cm of the outer sheath to expose the cable screen as shown below.

Cables should be segregated from high voltage cables and follow good installation practice

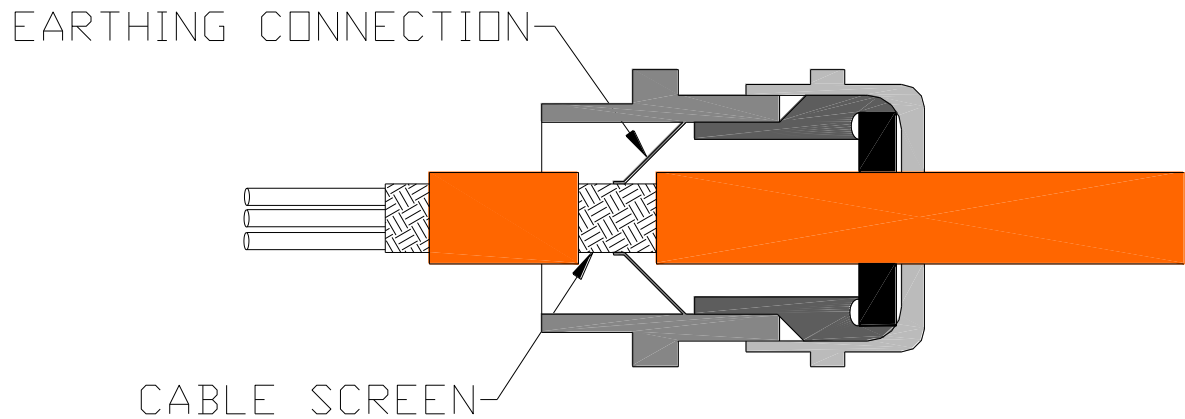


Figure 28 Control unit relay cable assembly

Feed the cable into the control unit via a metal IP65 EMC gland supplied, ensuring that the metal prongs make contact with the exposed cable screen as shown.

2.7.3 Control Unit to Detector Connections

At the Detector, screw the connector to the top of the Detector.



Figure 29 Detector cable assembly

At the Control Unit, screw the connector to the input required.

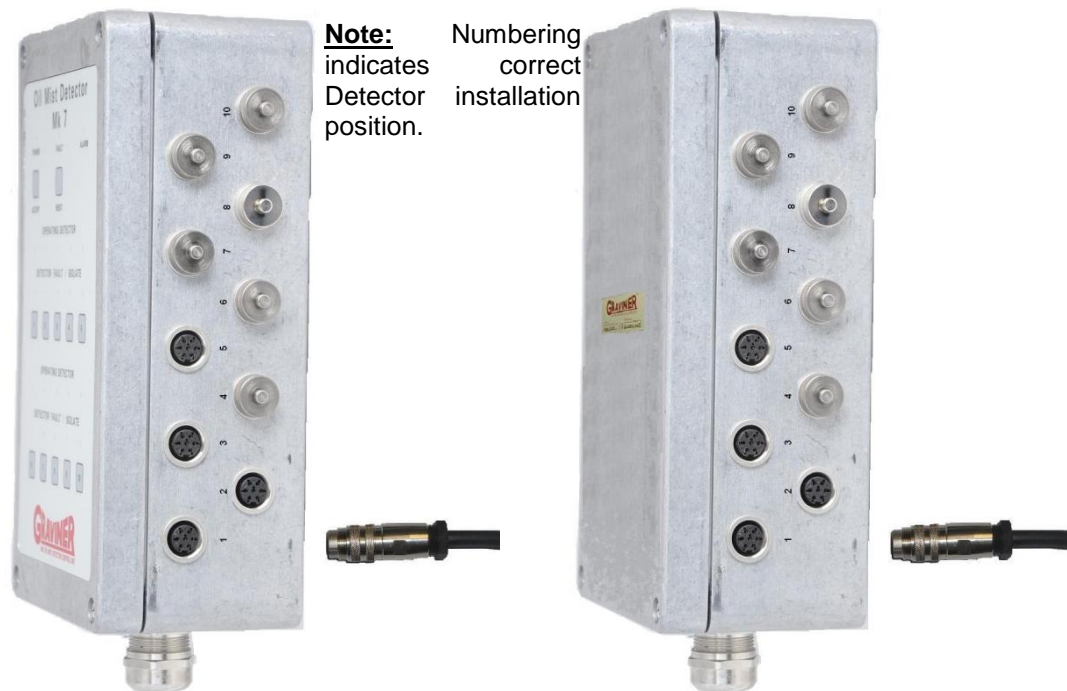


Figure 30 Control unit - Detector cable assembly

2.8 SYSTEM CHECKS PRIOR TO SWITCHING ON

- 2.8.1 Ensure that the 24v DC input power supply cable is connected correctly at each Control Unit (if more than one installed).
- 2.8.2 Ensure that the Modbus Communication (if required) is terminated correctly at each Control Unit (if more than one installed and/or Remote Indication Display installed or connected to AMS).
 - 2.8.2.1 If more than one Control Unit is installed, please ensure the End of Line (EOL) jumpers are removed from all Control Units (refer Figure 18) **except** for the highest Modbus addressed Control Unit.
 - 2.8.2.2 Make sure that the Modbus address's are set as required, refer section 2.9.1 for procedure.
- 2.8.3 Ensure that the Back-up Alarm, Pre Alarm, Fault and Slowdown/Shutdown relays are connected correctly at each Control Unit (if more than one installed).
- 2.8.4 Ensure the detectors are connected to each Control Unit in the correct number sequence.
- 2.8.5 Check the cable run of all Modbus Communication cables between all installed Control Units to each other and to the Remote Indication Display (If Installed) or AMS to ensure that it is not damaged.
- 2.8.6 Ensure all unused Glands are removed from all Control Units and replaced by Blanking Plugs.
- 2.8.7 Ensure that the Modbus Communication and power supply cables are connected correctly at the Remote Display Unit (If installed).
- 2.8.8 Ensure that the input voltage at the Control Unit(s) and the Remote Display Unit (If installed) is a clean 24 V dc (+30%, - 25%)
- 2.8.9 When all of the above have been checked and are satisfactory the system is ready to switch on.
- 2.8.10 Allow the engine to reach its' normal operating temperature before continuing to System Configuration and Commissioning.

Oil Mist alarm levels should be set to a level above the actual normal operating level displayed,

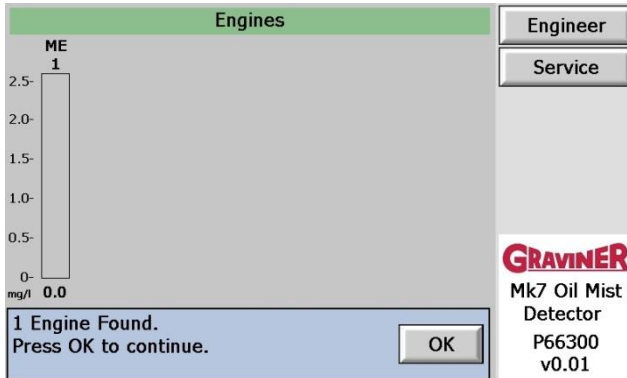
2.9 SYSTEM SETUP / CONFIGURATION – WITH A REMOTE DISPLAY UNIT

When all of the connections have been completed and checked, power up the Control Unit(s) and Remote Display Unit, the following power up screen will show for a few seconds on the Remote Display Unit.

If there is more than one Control Unit connected to the display the Modbus address needs to be set up via the USB connection on the Control Unit before it can talk to the Remote Display Unit. Please refer to section 2.9.1.1 for the Modbus setup



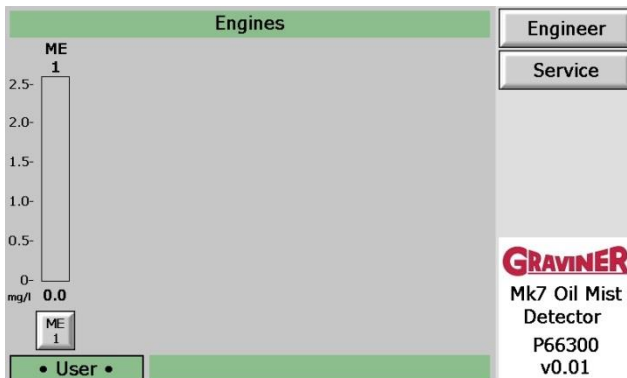
Figure 31 Screen Shot 1



After a few seconds the following will be seen on the Remote Display Unit, this shows one engine connected but may show up to ten engines.

Press 'OK'

Figure 32 Screen Shot 2



Press the 'Engineer' button to log in as an Engineer.

Note – To setup Engine and Detectors and Save Logs, you must be logged in as an Engineer.

Figure 33 Screen Shot 3

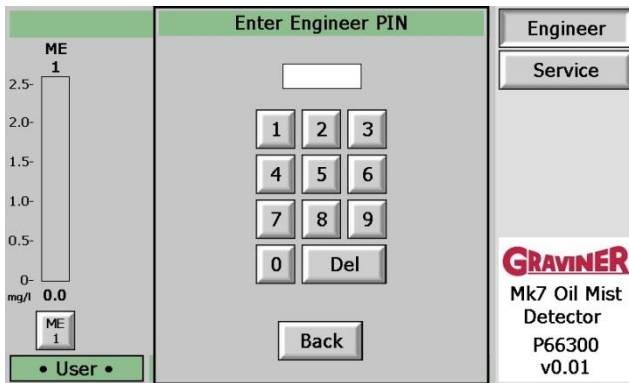


Figure 34 Screen Shot 4

Enter password 012345.

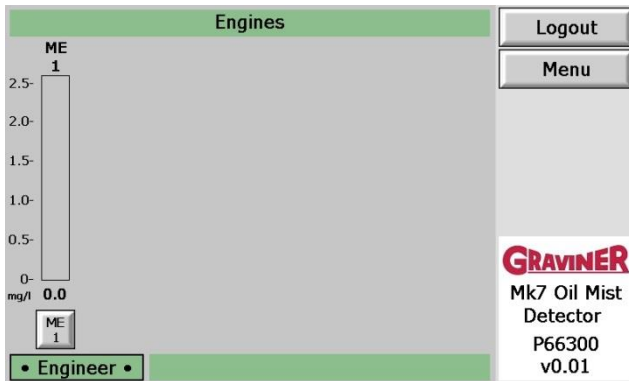


Figure 35 Screen Shot 5

Press 'Menu' Button to display the Engineers menu.

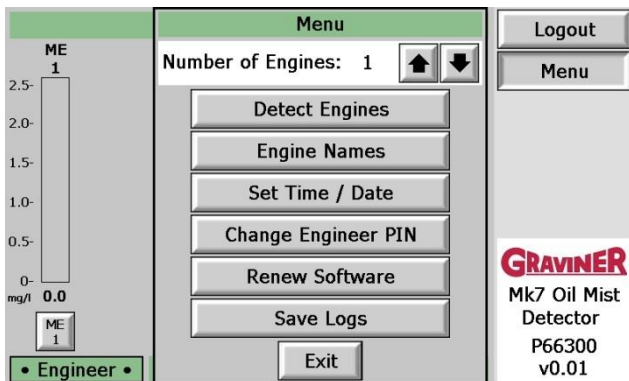


Figure 36 Screen Shot 6

To set or change Engine Names press 'Engine Names'.

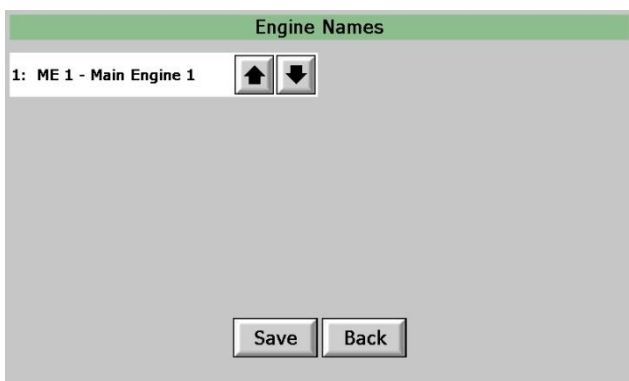


Figure 37 Screen Shot 7

Press the up and down arrows to cycle through possible Engine Names, this figure shows one engine connected but may show up to ten.

Please see below for the full list of Engine Names.

Press 'Save' once your desired name is selected for Engines.

Engine Name Selection List (supported by Control Unit Software versions to P66200-107 and lower)

Text label	Displayed on Icon as
Main Engine 1	ME 1
Main Engine 2	ME 2
Fuel Supply Unit	FSU
Generator 1	G/E 1
Generator 2	G/E 2
Generator 3	G/E 3
Generator 4	G/E 4
Generator 5	G/E 5
Generator 6	G/E 6
Generator 7	G/E 7
Generator 8	G/E 8
Generator 9	G/E 9
Generator 1	GEN 1
Generator 2	GEN 2
Generator 3	GEN 3
Generator 4	GEN 4
Generator 5	GEN 5
Generator 6	GEN 6
Generator 7	GEN 7
Generator 8	GEN 8
Generator 9	GEN 9

Text label	Displayed on Icon as
Auxiliary Engine 1	AUX 1
Auxiliary Engine 2	AUX 2
Auxiliary Engine 3	AUX 3
Auxiliary Engine 4	AUX 4
Auxiliary Engine 5	AUX 5
Auxiliary Engine 6	AUX 6
Auxiliary Engine 7	AUX 7
Auxiliary Engine 8	AUX 8
Auxiliary Engine 9	AUX 9
No name	

Engine Name Selection List (supported by Control Unit Software versions P66200-108 and above)

Text label	Displayed on Icon as
Main Engine 1	ME 1
Main Engine 2	ME 2
Main Engine 3	ME 3
Main Engine 4	ME 4
Main Engine 5	ME 5
Main Engine 6	ME 6
Main Engine 7	ME 7
Main Engine 8	ME 8
Main Engine 9	ME 9
Main Engine 10	ME 10
Main Engine Starboard	ME STB
Main Engine Port	ME PRT
Main Engine Forward	ME FWD
Main Engine Aft	ME AFT
Main Engine 1 Forward	ME1 FWD
Main Engine 1 Aft	ME1 AFT
Main Engine 2 Forward	ME2 FWD
Main Engine 2 Aft	ME2 AFT
Main Engine 3 Forward	ME3 FWD
Main Engine 3 Aft	ME3 AFT
Main Engine 4 Forward	ME4 FWD
Main Engine 4 Aft	ME4 AFT
Generator 1	G/E 1
Generator 2	G/E 2
Generator 3	G/E 3
Generator 4	G/E 4
Generator 5	G/E 5
Generator 6	G/E 6
Generator 7	G/E 7
Generator 8	G/E 8
Generator 9	G/E 9

Text label	Displayed on Icon as
Generator 1	GEN 1
Generator 2	GEN 2
Generator 3	GEN 3
Generator 4	GEN 4
Generator 5	GEN 5
Generator 6	GEN 6
Generator 7	GEN 7
Generator 8	GEN 8
Generator 9	GEN 9
Auxiliary Engine 1	AUX 1
Auxiliary Engine 2	AUX 2
Auxiliary Engine 3	AUX 3
Auxiliary Engine 4	AUX 4
Auxiliary Engine 5	AUX 5
Auxiliary Engine 6	AUX 6
Auxiliary Engine 7	AUX 7
Auxiliary Engine 8	AUX 8
Auxiliary Engine 9	AUX 9
Unit 1	UNI 1
Unit 2	UNI 2
Unit 3	UNI 3
Unit 4	UNI 4
Fuel Supply Unit 1	FSU 1
Fuel Supply Unit 2	FSU 2
Fuel Supply Unit 3	FSU 3
Fuel Supply Unit 4	FSU 4
No name	

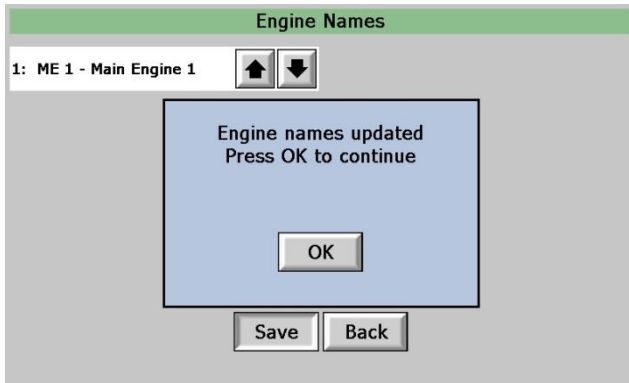


Figure 38 Screen Shot 8

Press 'OK'.

Figure 36 will then be displayed.

To change the Time & Date press 'Set Time / Date'

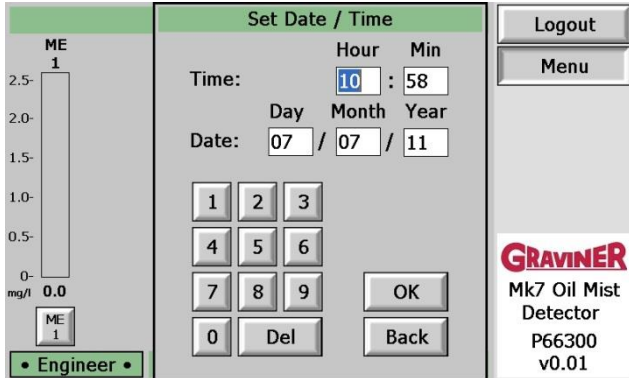


Figure 39 Screen Shot 9

Use numeric keys to set the Time and Date. Press 'OK' when complete

Note – Time and Date must be entered even if the correct Time and Date is displayed.

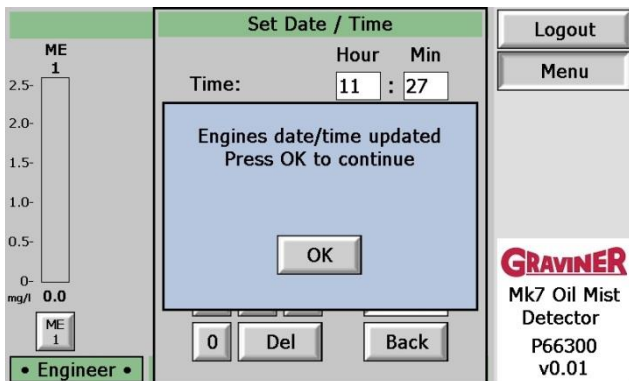


Figure 40 Screen Shot 10

Press 'OK', Figure 36 will then be displayed.

To change the Engineer PIN press 'Change Engineer PIN'.

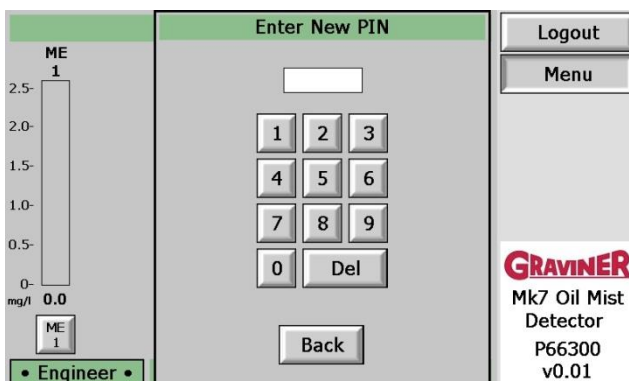


Figure 41 Screen Shot 11

Use numeric keys to enter new pin of 6 digits and then store in a safe place where only authorised users can access it

If the PIN number is lost, please contact UTC Fire & Security UK Ltd.

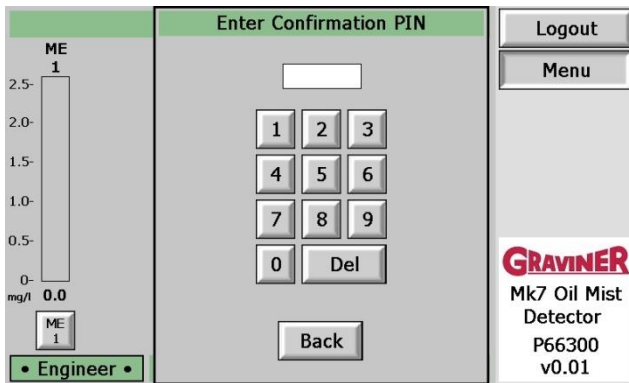


Figure 42 Screen Shot 12

Use numeric keys to re enter new pin of 6 digits.

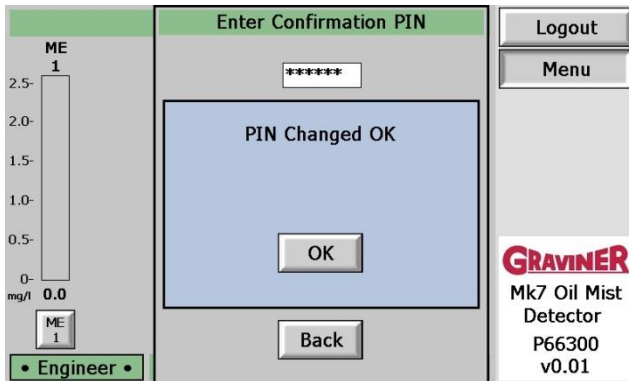


Figure 43 Screen Shot 13

Press 'OK'.

Figure 36 will then be displayed.

To save the event Log press 'Save Logs'

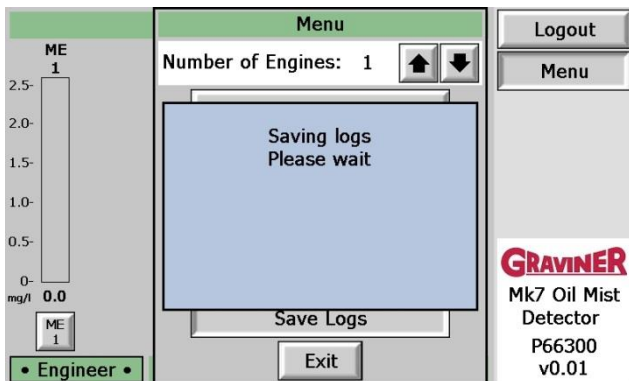


Figure 44 Screen Shot 14

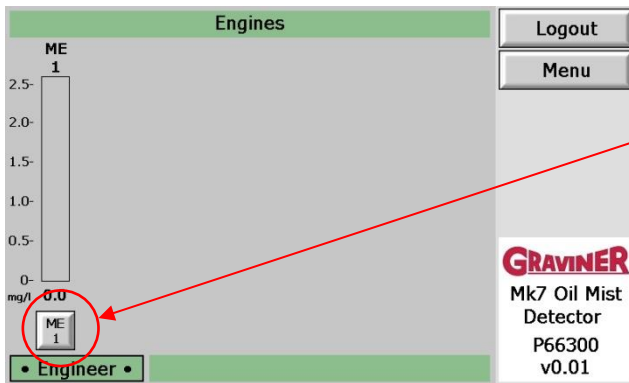


Figure 45 Screen Shot 15

Press 'OK' to return to Figure 36.

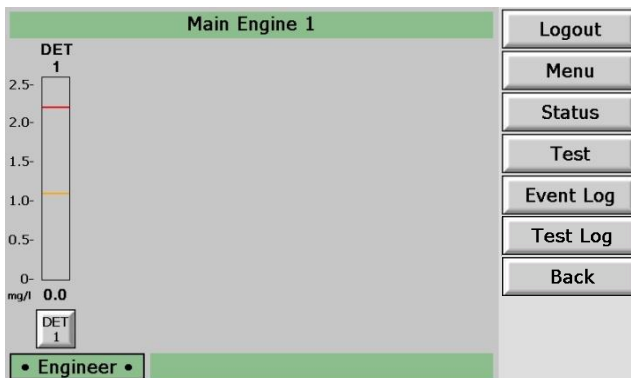
Note – Once the Logs are saved, only UTC Graviner Authorised Service Agents can download them.

Press 'Exit' to return to Engines Overview screen (Figure 33)



To setup the Detectors on each Engine, press the button under the mg/l display for the Engine being setup.

Figure 46 Screen Shot 16



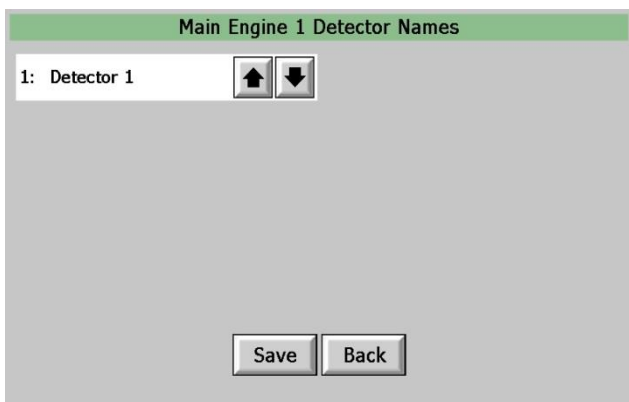
Press 'Menu' to display the Engine Menu.

Figure 47 Screen Shot 17



To set or change Detector Names press 'Detector Names'.

Figure 48 Screen Shot 18



Press the up and down arrows to scroll through possible Detector Names, this figure shows one detector connected but may show up to ten Detectors.

Please see below for the full list of Detector Names.

Press 'Save' once your desired name is selected for Detectors.

Figure 49 Screen Shot 19

Detector Name Selection List (supported by Control Unit Software versions P66200-107 and below)

Text label	Displayed on Icon as
Detector 1	DET 1
Detector 2	DET 2
Detector 3	DET 3
Detector 4	DET 4
Detector 5	DET 5
Detector 6	DET 6
Detector 7	DET 7
Detector 8	DET 8
Detector 9	DET 9
Detector 10	DET 10
Detector 11	DET 11
Detector 12	DET 12
Detector 13	DET 13
Detector 14	DET 14
Detector 15	DET 15
Detector 16	DET 16
Detector 17	DET 17
Detector 18	DET 18
Detector 19	DET 19
Detector 20	DET 20
Cylinder 1	CYL 1
Cylinder 2	CYL 2
Cylinder 3	CYL 3
Cylinder 4	CYL 4
Cylinder 5	CYL 5
Cylinder 6	CYL 6
Cylinder 7	CYL 7
Cylinder 8	CYL 8
Cylinder 9	CYL 9
Cylinder 10	CYL 10
Cylinder 11	CYL 11
Cylinder 12	CYL 12
Cylinder 13	CYL 13

Text label	Displayed on Icon as
Cylinder 14	CYL 14
Cylinder 15	CYL 15
Cylinder 16	CYL 16
Cylinder 17	CYL 17
Cylinder 18	CYL 18
Cylinder 19	CYL 19
Cylinder 20	CYL 20
Fuel Supply Unit 1	FSU 1
Fuel Supply Unit 2	FSU 2
Fuel Supply Unit 3	FSU 3
Fuel Supply Unit 4	FSU 4
Fuel Supply Unit 5	FSU 5
Chain Case	C/C
Gear Box	G BOX
Gear Box 1	GB 1
Transfer Box	T BOX
Thrust Bearing	THR BRG
Moment Compensator	MOM CPT

Detector Name Selection List (supported by Control Unit Software versions P66200-108 and above)

Text label	Displayed on Icon as
Detector 1	DET 1
Detector 2	DET 2
Detector 3	DET 3
Detector 4	DET 4
Detector 5	DET 5
Detector 6	DET 6
Detector 7	DET 7
Detector 8	DET 8
Detector 9	DET 9
Detector 10	DET 10
Detector 11	DET 11
Detector 12	DET 12
Detector 13	DET 13
Detector 14	DET 14
Detector 15	DET 15
Detector 16	DET 16
Detector 17	DET 17
Detector 18	DET 18
Detector 19	DET 19
Detector 20	DET 20
Cylinder 1	CYL 1
Cylinder 2	CYL 2
Cylinder 3	CYL 3
Cylinder 4	CYL 4
Cylinder 5	CYL 5
Cylinder 6	CYL 6
Cylinder 7	CYL 7
Cylinder 8	CYL 8
Cylinder 9	CYL 9
Cylinder 10	CYL 10
Cylinder 11	CYL 11
Cylinder 12	CYL 12
Cylinder 13	CYL 13

Text label	Displayed on Icon as
Cylinder 14	CYL 14
Cylinder 15	CYL 15
Cylinder 16	CYL 16
Cylinder 17	CYL 17
Cylinder 18	CYL 18
Cylinder 19	CYL 19
Cylinder 20	CYL 20
Fuel Supply Unit 1	FSU 1
Fuel Supply Unit 2	FSU 2
Fuel Supply Unit 3	FSU 3
Fuel Supply Unit 4	FSU 4
Fuel Supply Unit 5	FSU 5
Chain Case	C/C
Gear Box	G BOX
Gear Box 1	GB 1
Gear Box 2	GB 2
Gear Box 3	GB 3
Gear Box 4	GB 4
Gear Box 5	GB 5
Gear Box 6	GB 6
Transfer Box	T BOX
Thrust Bearing	THR BRG
Moment Compensator	MOM CPT
Hydraulic Power Station 1	HPS 1
Hydraulic Power Station 2	HPS 2
Hydraulic Power Station 3	HPS 3
Hydraulic Power Station 4	HPS 4
Fore Comp	F/C
Thrust Bearing	T/B
Chain Case Forward	C/C F
Chain Case Aft	C/C A

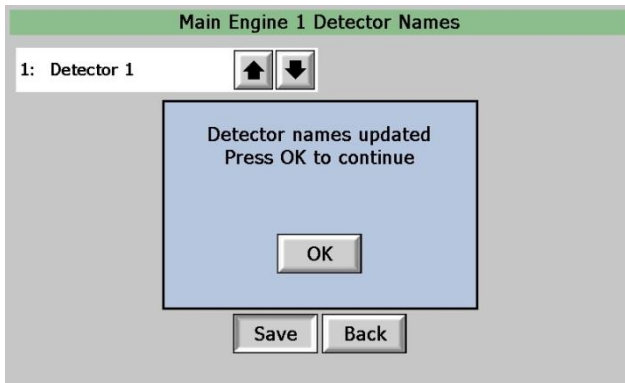


Figure 50 Screen Shot 20

Press 'OK'. Figure 48 will then be displayed.

Press 'Exit'.

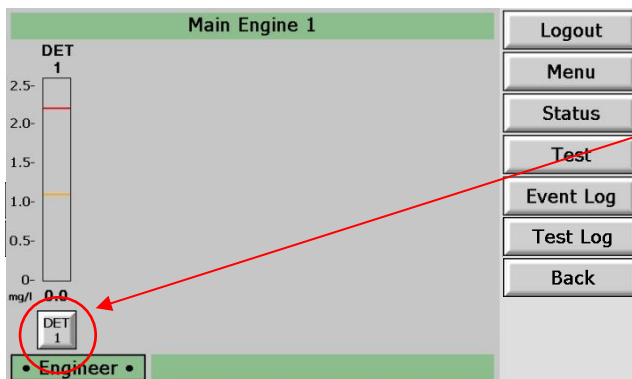


Figure 51 Screen Shot 21

To set the individual Detector parameters, press the button under the mg/l display for the required detector.

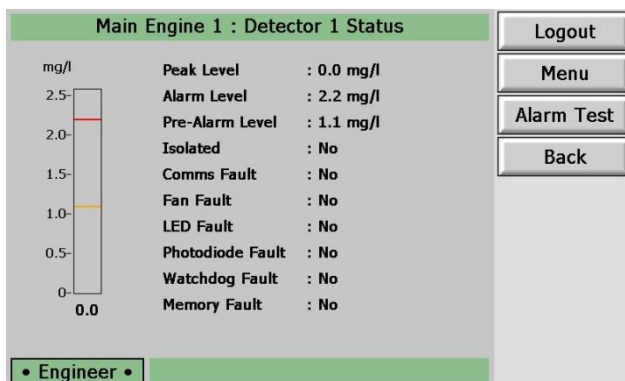


Figure 52 Screen Shot 22

Press 'Menu' to display the Detector Menu.

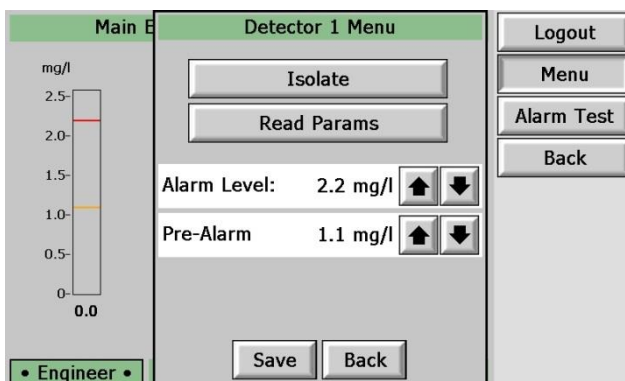


Figure 53 Screen Shot 23

Press the up and down arrows to select the desired Alarm and Pre Alarm Levels.

Slow/Shutdown Alarm Limits 1.3 – 2.4mg/l

Pre-Alarm Limits 0.5 – 1.2mg/l

Default Settings

Slow/Shutdown Alarm – 1.8mg/l

Pre-Alarm – 0.9mg/l

Press 'Save' once complete.



Figure 54 Screen Shot 24

Press 'OK'.

Figure 52 will then be displayed. Press 'Back' to return to Figure 51.

Repeat setting Detector settings for the number of Detectors connected.

Once Detectors on Engine 1 have been set, Press 'Back' to return to Engine Overview screen.

Repeat setting Engine Names & Detector settings for the number of Engines connected.

The OMD Mk7 System should now be setup.

2.9.1 Control Unit Modbus Addressing

When more than one Control Unit is connected on 1 system, the Modbus address needs to be set up in each Control Unit before the system will work properly.

NOTE – For multiple Control Units per system, each Control Unit must have its own Control Unit Address and they must be sequential, i.e. 01. 02. 0310

All Control Units will come shipped as Modbus address 01 (1st Control Unit)

There are 2 methods to change the Modbus address, the first is via the Membrane (refer Section 2.9.1.1), the second is via the USB connection on the PCB (refer Section 2.9.1.2)

2.9.1.1 To change the Modbus address via the front Membrane

- a) With no Faults or Alarms on the Control Unit to be addressed, press the Accept button for a minimum 1sec. (Refer Figure 55)
- b) Then press the Reset button for a minimum of 1sec. (Refer Figure 55)

NOTE – The Reset button must be pressed within 5sec of pressing the Accept button



Press 'Accept' button for a minimum of 1sec



Press 'Reset' button for a minimum of 1sec

Figure 55 Control Unit Membrane

- a. The current Modbus address of the Control Unit will now be flashing (1sec on, 1sec off) (Refer Figure 56)
- b. Press the numerical button required until the Green LED above the pressed button flashes. (ie For Modbus address 03, press No. 3 button(Refer Figure 56)

NOTE – The numerical button must be pressed within 10sec of pressing the Reset button



Current Modbus address flashing



Press required numerical button for 1sec

Figure 56 Control Unit Membrane

- c. The Green LED above the button pressed will now be flashing. The Control Unit will automatically store this new Modbus address.
- d. When the address has been changed, the Control Unit returns to normal operation and indicates the number of detectors connected.

Repeat the above for the number of Control Units installed per system.

After the addresses have been changed, please ensure that both EOL jumpers are fitted to the last Control Unit only, all other Control Units need to have both the EOL jumpers removed.

Refer Figure 18 for EOL jumper positions.

NOTE – The Control Units 24Vdc Power Supply needs to be removed for a period of 10sec and re-applied to ensure Modbus address changes are recognized on the Modbus network.

Once all Control Units have the correct Modbus addresses, the Remote Display Unit will need to be programmed to detect the required number of engines on the system (refer Section 2.9.1.4)

2.9.1.2 To change the Modbus address via the USB connection on the PCB (Refer Figure 57)

- a. Connect the 24Vdc power supply to the Control Unit to be changed.
- b. Connect the USB-B end to the USB socket located on the PCB inside the Control Unit (refer Figure 57)

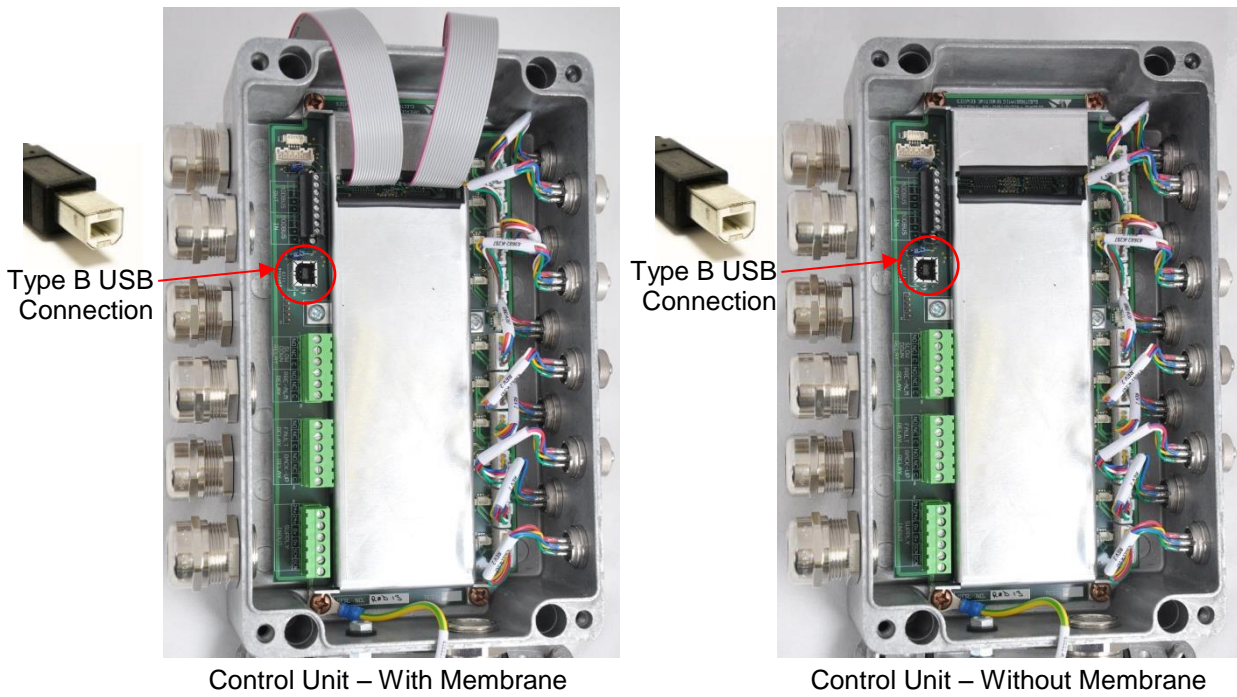


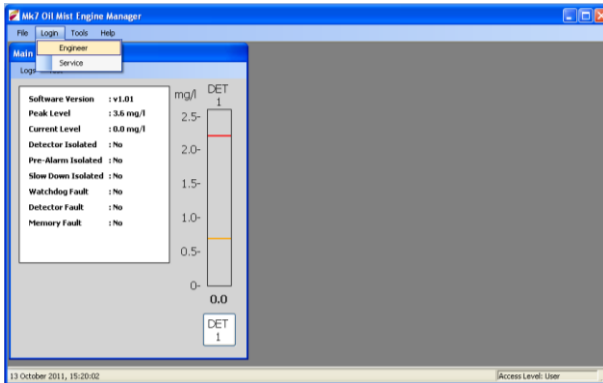
Figure 57 Control Unit – USB Connector

- c. Connect the other end of the USB Lead to a USB socket on your computer (refer Figure 58)



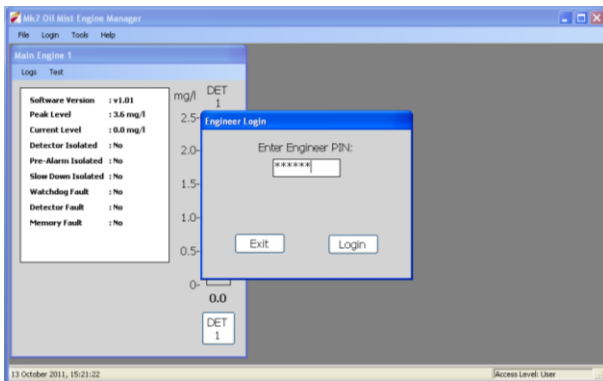
Figure 58 Computer Connection – Type A USB Connector

2.9.1.3 With the above cables connected, open the 'Mk7 Oil Mist Engine Manager' software on the computer. Version 103 and above of this software does NOT require a USB Dongle, previous versions require the USB Dongle supplied to be connected to the computer)



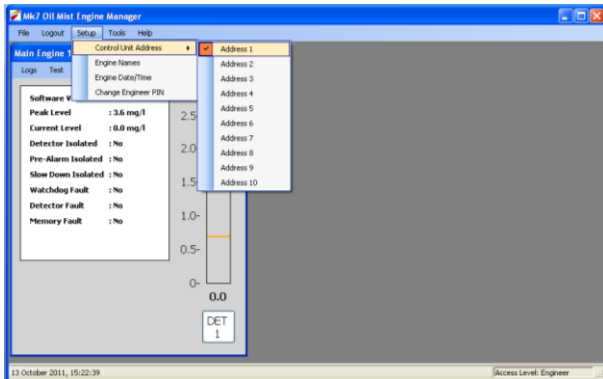
Click 'Login', then 'Engine'

Figure 59 USB Screen Shot 1



Enter 012345 and press 'Login'

Figure 60 USB Screen Shot 2



Select the required Control Unit Address (this is the Modbus address)

Figure 61 USB Screen Shot 3

Repeat the above for the number of Control Units installed per system.

After the address's have been changed, please ensure that the EOL jumpers are fitted to the last Control Unit only, all other Control Units need to have both the EOL jumpers removed.

Refer Figure 18 for EOL jumper positions.

NOTE – The Control Units 24Vdc Power Supply needs to be removed for a period of 10sec and re-applied to ensure Modbus address changes are recognized on the Modbus network.

Once all Control Units have the correct Modbus addresses, the Remote Display Unit will need to be programmed to detect the required number of engines on the system (refer Section 2.9.1.4)

2.9.1.4 Once all Control Units have the correct Modbus addresses, the Remote Display Unit will need to be programmed to detect the required number of engines on the system.

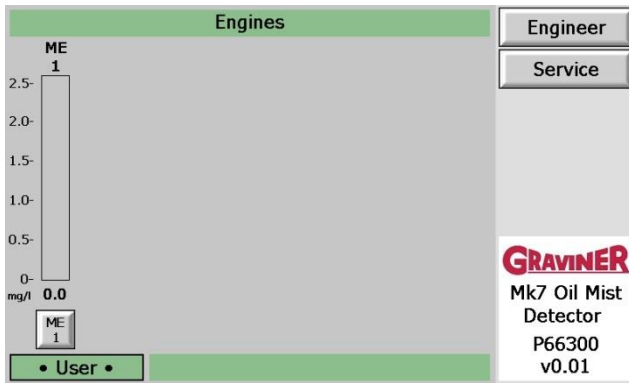


Figure 62 Detect Engine Screen Shot 1

Press the 'Engineer' button to log in as an Engineer.

Note – To detect Engines, you must be logged in as Engineer.

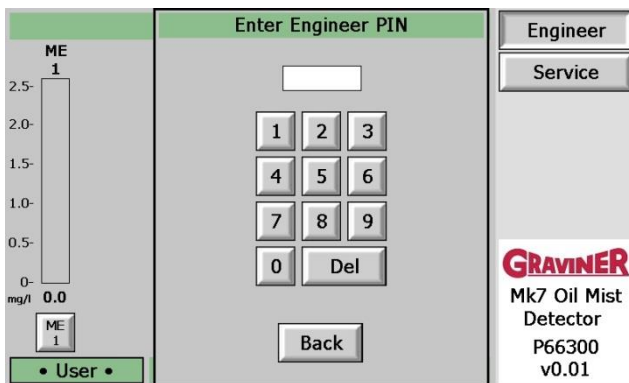


Figure 63 Detect Engine Screen Shot 2

Enter password 012345.

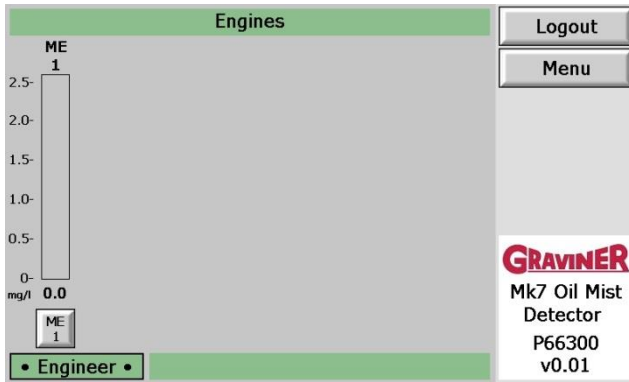


Figure 64 Detect Engine Screen Shot 3

Press 'Menu' Button to display the Engineers menu.

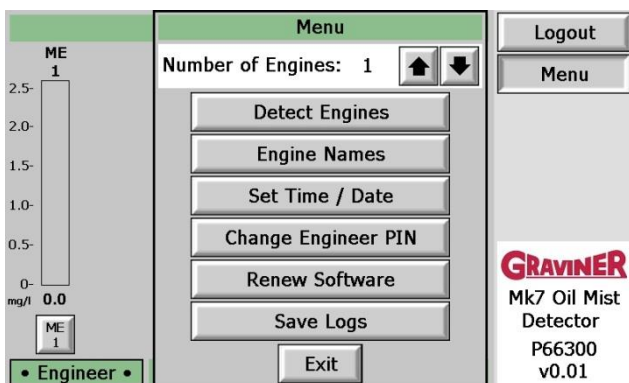
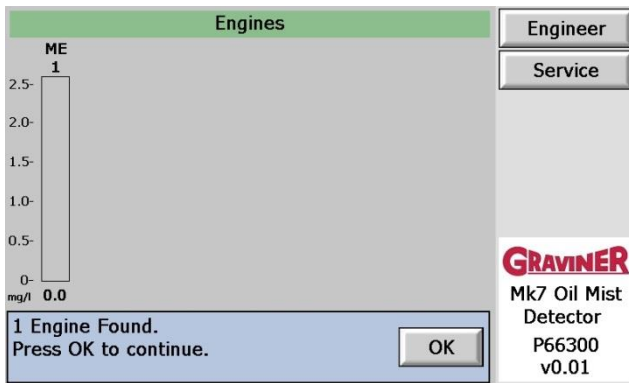


Figure 65 Detect Engine Screen Shot 4

Press the up and down arrows to select the number of Engines/Control units connected on the system.

Press 'Detect Engines'



After a few seconds the following will be seen on the Remote Display Unit, this shows one engine connected but may show up to ten.

Press 'OK'

Figure 66 Detect Engine Screen Shot 5

2.9.2 Detector Smoke Alarm Test

One of two methods may be used to conduct the Smoke Alarm Test. Testing should be undertaken with the detector(s) fitted, electrically connected, functioning and configured as described in the instruction manual.

Note: Isolation of the output relays (Pre Alarm and Slow/Shutdown Relays) is required before commencing the smoke alarm test. If the Back-up Alarm Relay is connected to the engine slowdown or shutdown system this should be disconnected.

Warning: Carrying out this test without isolation or disconnection of the output relays will cause the engine slowdown or shutdown system to operate if connected.

Method 1 – Using a Wick

- a. Cut a length of wick approximately 30 mm long. Assemble the smoke tester by pushing the wick into the wick holder fitted with the pipette bulb. Press the nylon pipe into the pipe connector (refer to Figure 67).

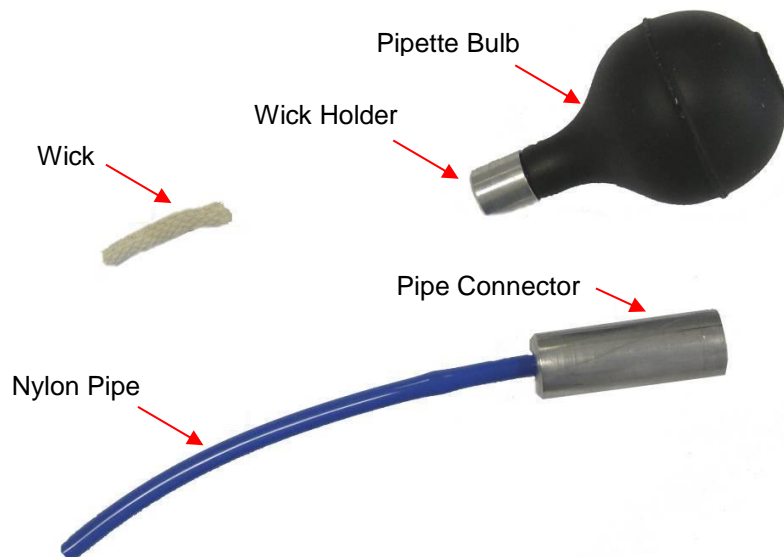


Figure 67 Smoke Tester

- b. Push the nylon pipe of the smoke tester into the connector on the side of the detector base body (refer to Figure 68).



Figure 68 Smoke Test

- c. Dip the wick into the bottle of smoke oil and reseal the bottle firmly
Note: Only a small quantity of oil is required.
- d. Ignite the wick of the smoke tester and blow out the flame. Squeeze the pipette bulb to keep the wick smoking.
Note: Care to be taken with this activity at all times.
- e. While the wick is still smouldering, insert it into the pipe connector and squeeze the pipette bulb.
- f. Observe the wick is still smouldering, insert nylon pipe into the pipe connector of the detector and squeeze the pipette bulb.
- g. After tests are completed the Detector Peak Level readings should be erased. This can be done via the Engine Menu using Clear Peak. (refer Figure 46)
- h. To release the pipe from the connector, press in the metal collar on the end of the connector at the same time as pulling the pipe out
- i. Remove the nylon pipe from the pipe connector for stowage purposes.
- j. The wick is reusable and can be left in the wick holder. Fully extinguish the wick after use at all times.
- k. Refer to the Material Safety Data Sheet in the event of health or safety issues.

Method 2 - Using Artificial Smoke

- a. Push the nylon pipe of the smoke tester into the connector on the side of the detector base body (refer to Figure 68).
- b. Using a can of artificial smoke, e.g. Smoke Check smoke detector tester, spray the artificial smoke in to the nylon pipe.
- c. After tests are completed the Detector Peak Level readings should be erased. This can be done via the Engine Menu using Clear Peak. (refer Figure 46)
- d. To release the pipe from the connector, press in the metal collar on the end of the connector at the same time as pulling the pipe out
- e. Remove the nylon pipe from the pipe connector for stowage purposes.
- f. Refer to the Material Safety Data Sheet in the event of health or safety issues.

Method 2 is recommended in situations where the use of a naked flame would be hazardous.

2.9.3 Back-Up Alarm

The Back-up Alarm is a hard wired link from each Detector installed on the system. This facility will allow any Detector which is in a fault condition and sees an oil mist level of 3.0mg/l or greater to produce a 'Back Up Alarm. This will produce operation of the Back-up Alarm Relay in the Control Unit; the Back-up Alarm will also override any Detector or Detectors that are isolated.

Whilst any Detectors are in a Back-up Alarm condition the Accept key is inoperative until the oil mist level drops below 3.0mg/l.

It is possible for a healthy Detector to produce a Back-up alarm if the level of oil rises very rapidly.

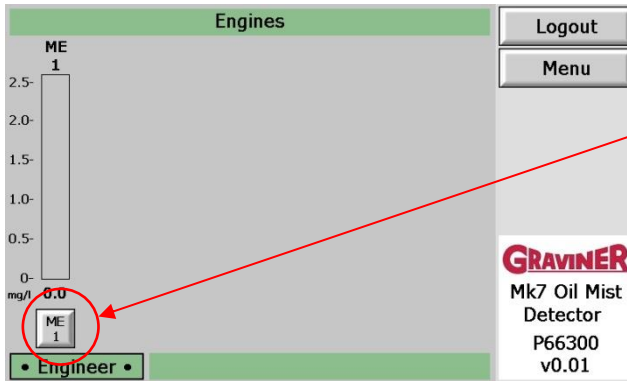
NOTE - The Back-up Alarm will not operate the Slowdown/Shutdown Relay

2.10 ISOLATION – USING THE REMOTE DISPLAY UNIT

If required, it is possible to isolate any individual Detector, a complete engine, engine Pre-Alarm or Slowdown/Shutdown relays. This allows maintenance to be carried out without affecting the remaining system. Isolation inhibits all alarms and faults for the isolated item except the Back-up Alarm, which is a fixed level.

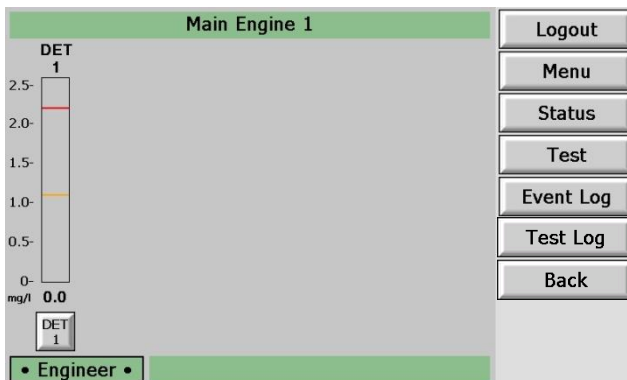
To prevent the possible activation of the Back-up Alarm Relay disconnect the cable from the top of the Detector unit.

2.10.1 Engine Isolation



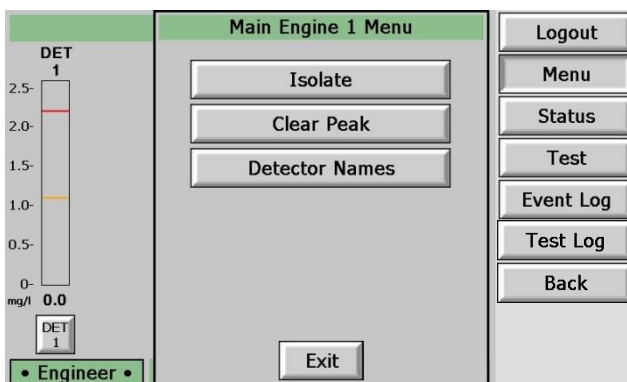
To Isolate Engine or detectors on the engine, press the button under the mg/l display for the Engine to be isolated. You must be in the Engineer level to carry out this function

Figure 69 Screen Shot 25



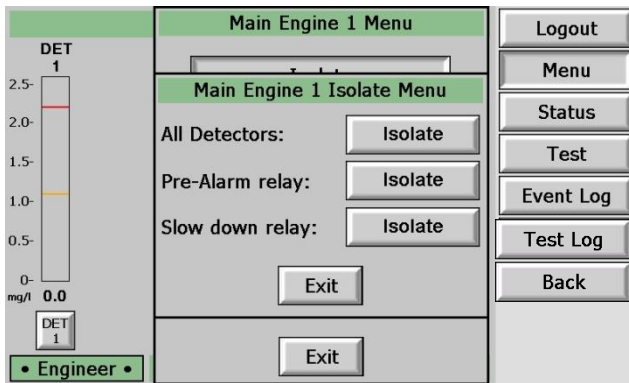
Press the 'Menu' button.

Figure 70 Screen Shot 26



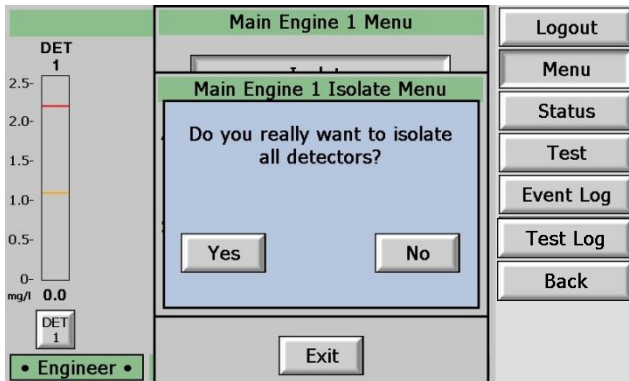
Press the 'Isolate' button.

Figure 71 Screen Shot 27



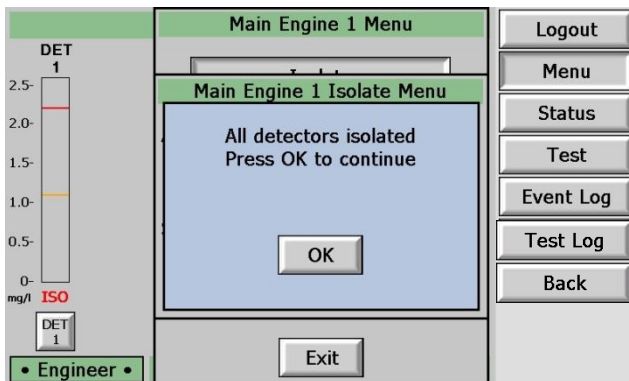
To Isolate All Detectors, press the 'Isolate' button.

Figure 72 Screen Shot 28



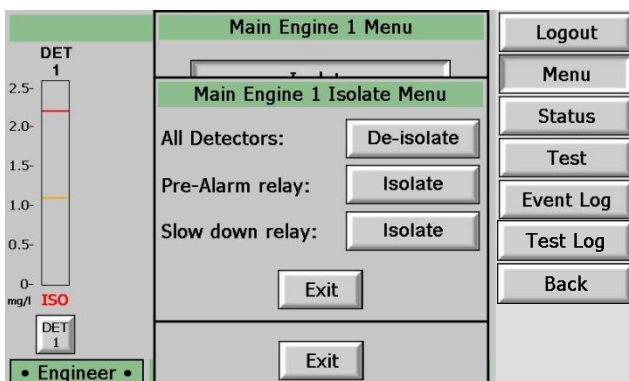
Press 'Yes' to Isolate All Detectors.

Figure 73 Screen Shot 29



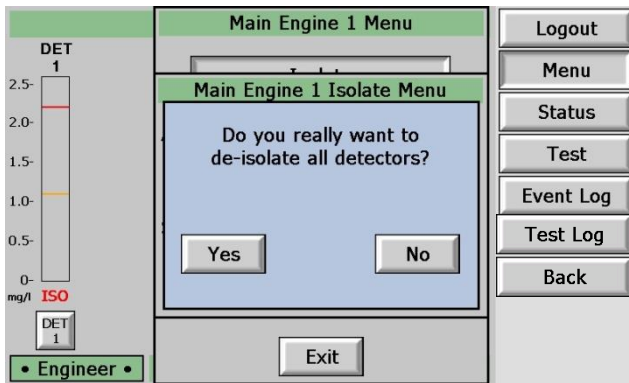
Press 'OK'

Figure 74 Screen Shot 30



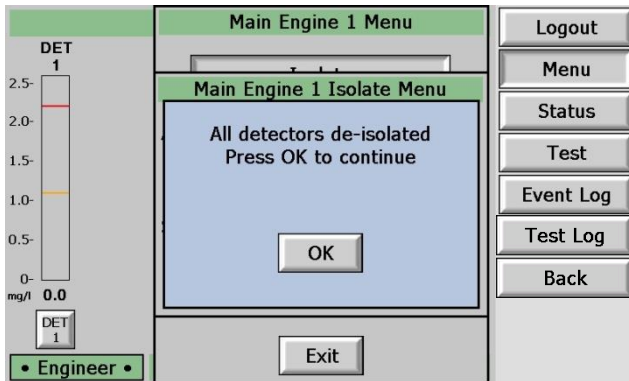
To De-Isolate All Detectors, press the 'De-Isolate' button.

Figure 75 Screen Shot 31



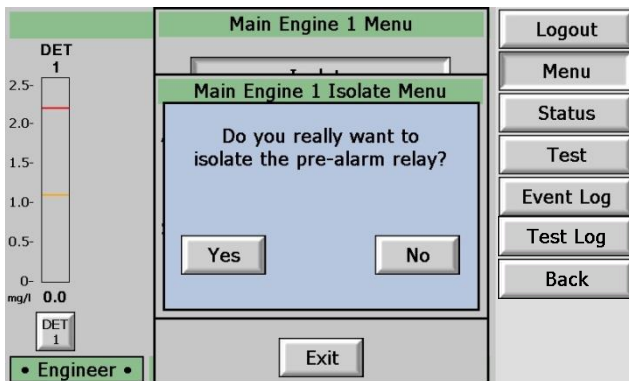
Press 'Yes' to De-Isolate All Detectors.

Figure 76 Screen Shot 32



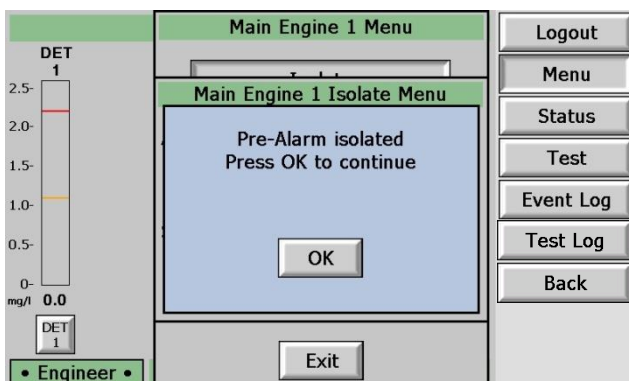
Press 'OK'
You will be returned to Figure 75.
To Isolate the Pre-Alarm Relay, press 'Isolate'

Figure 77 Screen Shot 33



Press 'Yes' to Isolate the Pre-Alarm relay.

Figure 78 Screen Shot 34



Press 'OK'

Figure 79 Screen Shot 35

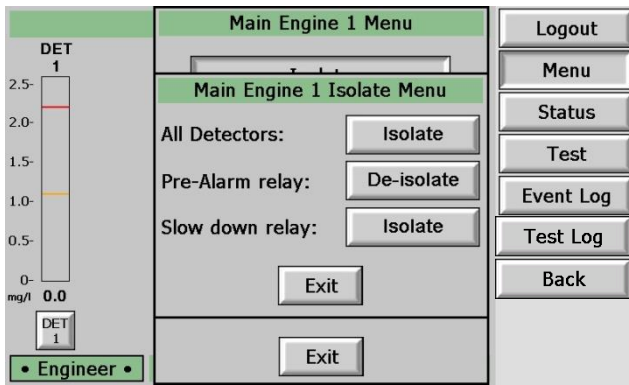


Figure 80 Screen Shot 36

To De-Isolate the Pre-Alarm relay, press the 'De-Isolate' button.

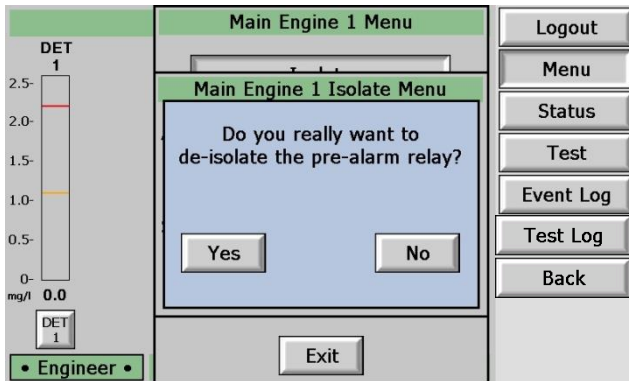


Figure 81 Screen Shot 37

Press 'Yes' to De-Isolate the Pre-Alarm relay.

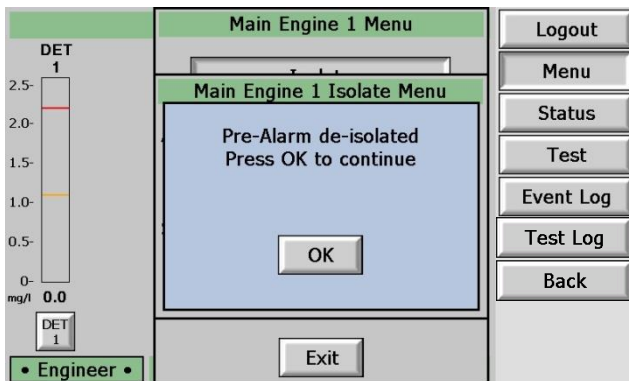


Figure 82 Screen Shot 38

Press 'OK'
You will be returned to Figure 75.
To Isolate the Slowdown/Shutdown Relay, press 'Isolate'

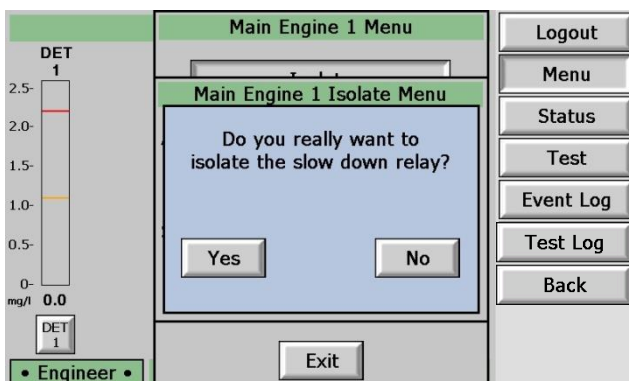
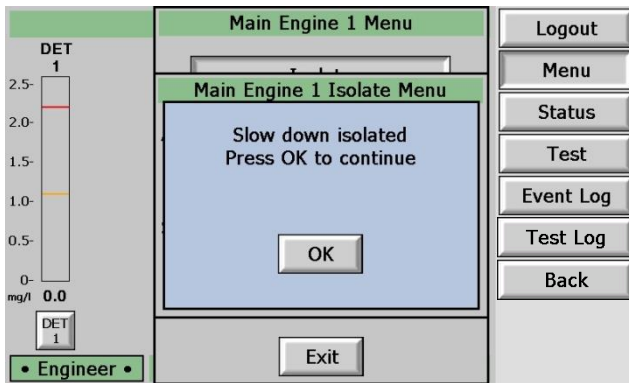


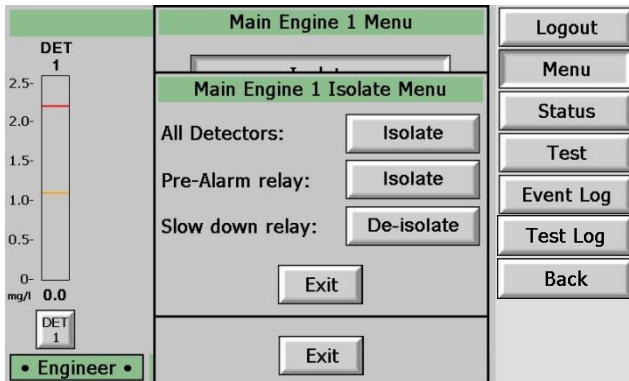
Figure 83 Screen Shot 39

Press 'Yes' to Isolate the Slowdown/Shutdown relay.



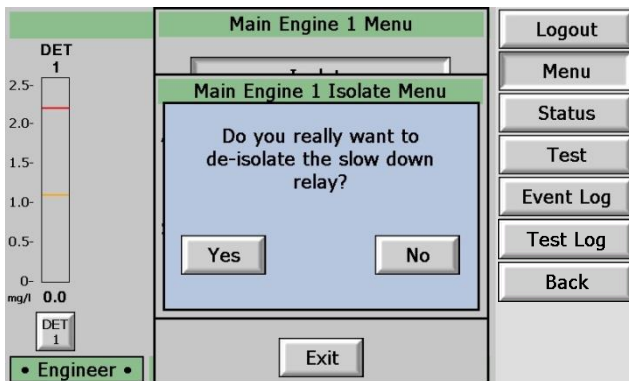
Press 'OK'

Figure 84 Screen Shot 40



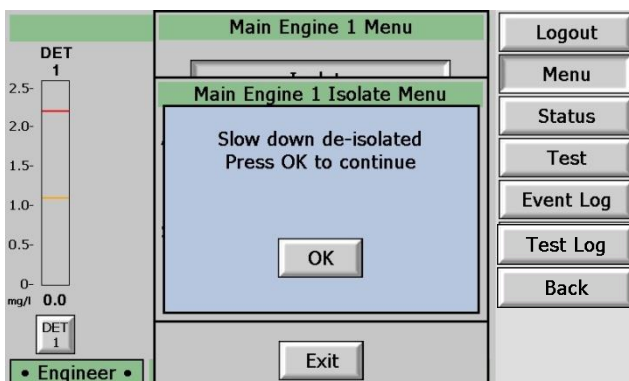
To De-Isolate the Slowdown/Shutdown relay, press the 'De-Isolate' button.

Figure 85 Screen Shot 41



Press 'Yes' to De-Isolate the Slowdown/Shutdown relay.

Figure 86 Screen Shot 42



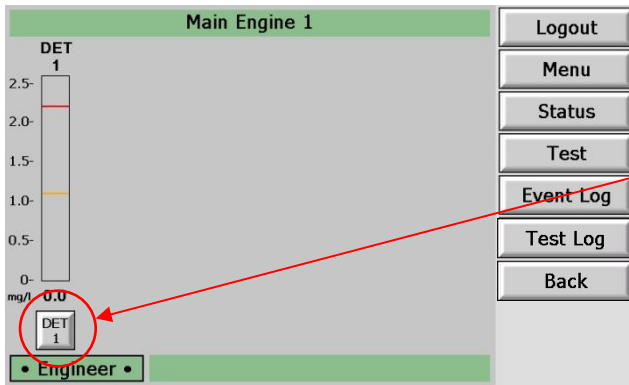
Press 'OK'

You will be returned to Figure 75.

Press 'Exit' to return to Figure 71. Press 'Exit' to return to Engine 1 overview screen (Figure 70).

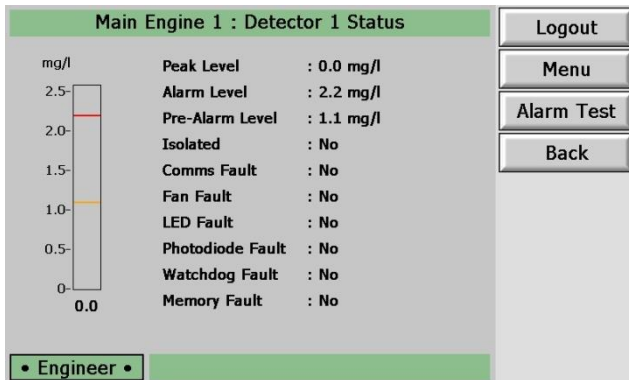
Figure 87 Screen Shot 43

2.10.2 Detector Isolation



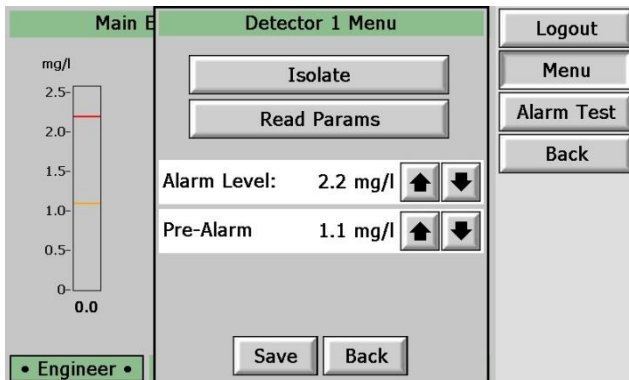
To Isolate single Detectors, press the button under the mg/l display for the required detector.

Figure 88 Screen Shot 44



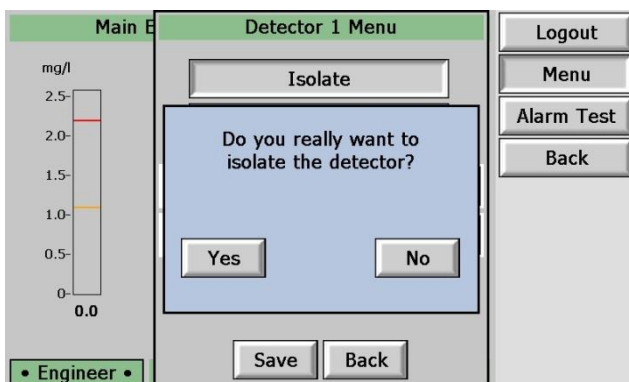
Press 'Menu'

Figure 89 Screen Shot 45



Press 'Isolate'

Figure 90 Screen Shot 46



Press 'Yes' to Isolate the Detector.

Figure 91 Screen Shot 47



Figure 92 Screen Shot 48

Press 'OK'

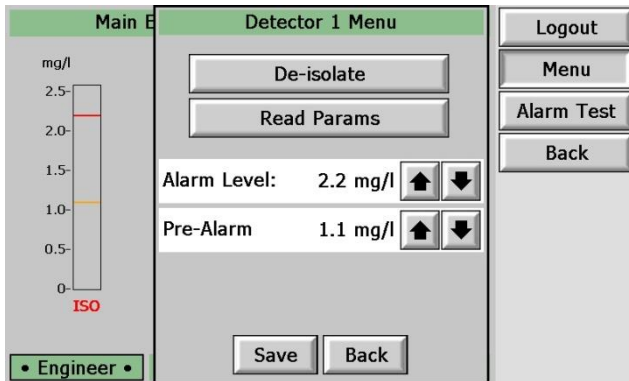


Figure 93 Screen Shot 49

To De-Isolate the selected Detector, press 'De-Isolate'

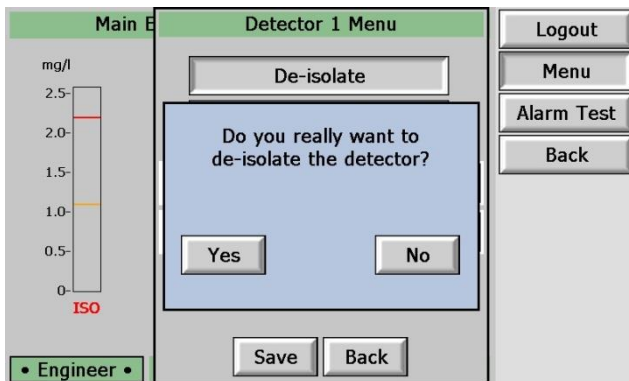


Figure 94 Screen Shot 50

Press 'Yes' to De-Isolate the Detector.

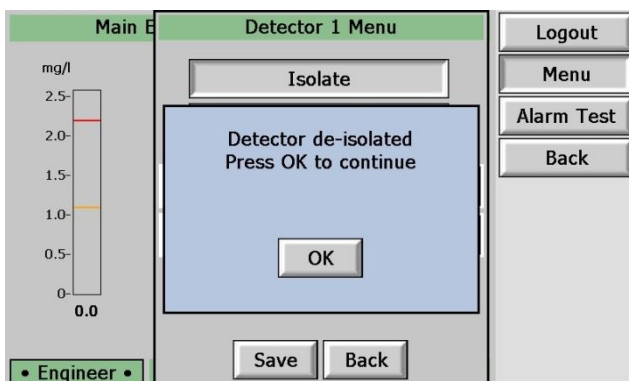


Figure 95 Screen Shot 51

Press 'OK'

You will be returned to Figure 93.

Press 'Back' button to return to Figure 89.

Press 'Back' button to return to Engine 1 overview screen (Figure 88).

Press 'Back' button to return to Engines overview screen.

2.10.3 Detector Isolation – Using the Membrane

To isolate a Detector at the Control Unit fitted with a Membrane, press the Detector number button for 2 seconds until the Amber LED is steady. (Refer Figure 94)

If using a Control Unit without Membrane then it is not possible to Isolate or De-Isolate Detectors. (refer Figure 3)

Note: Even with the Detector isolated the Back-up Alarm Relay can still be activated if the oil mist level increases above 3mg/l or light is introduced in to the detector. To prevent the possible activation of the Back-up Alarm Relay disconnect the cable from the top of the Detector unit.



Figure 96 Control Unit Membrane

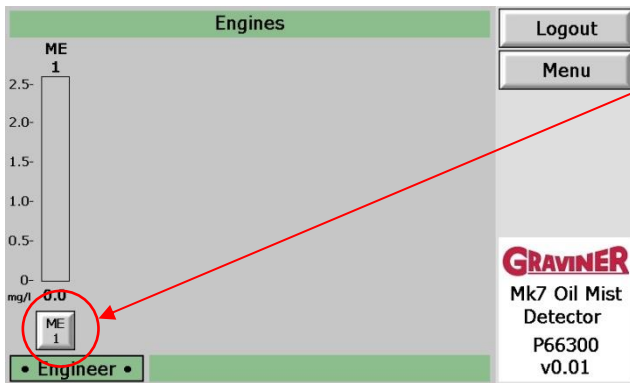
Repeat the above to de-isolate a Detector.

2.11 TEST MENU & EVENT LOG

This section will show how to Test the components in the OMD Mk7 system, and how to view the Event Log. The Test and Event Log instructions are the same for User Level and Engineer Level with the exception that the User Level **cannot** Test the Slowdown/Shutdown Relay.

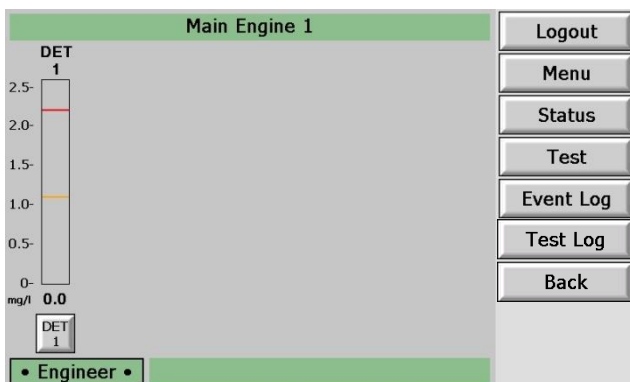
2.11.1 Test Menu.

Warning: Carrying out this test with the engine operating will cause the engine slowdown or shutdown system to operate if connected.



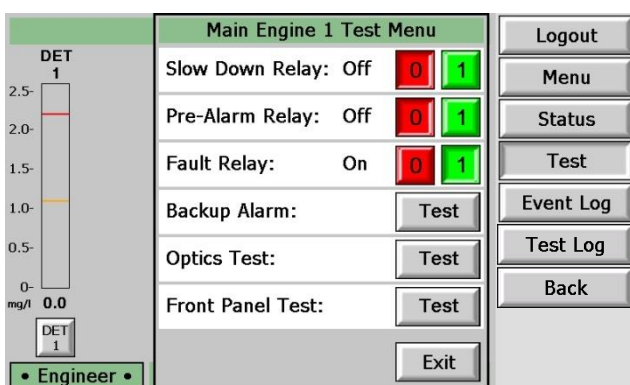
Select the desired Engine for testing.

Figure 97 Screen Shot 52



Press the 'Test' button.

Figure 98 Screen Shot 53



To test the Slowdown/Shutdown Relay, press the '1' button.

Figure 99 Screen Shot 54

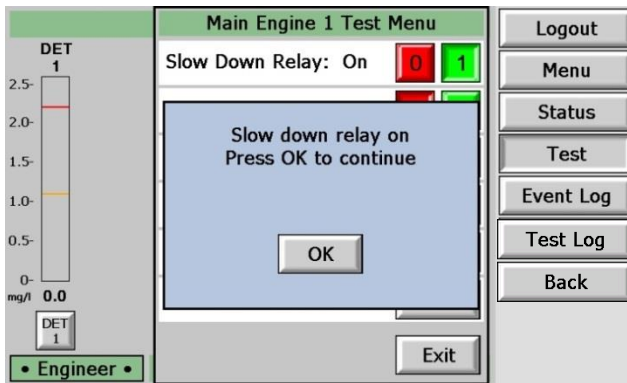


Figure 100 Screen Shot 55

Press 'OK'

You will be returned to Figure 99

To Test the Pre-Alarm Relay, press the '1' button.



Figure 101 Screen Shot 56

Press 'OK'

You will be returned to Figure 99.

To Test the Fault Relay, press the '0' button.



Figure 102 Screen Shot 57

Press 'OK'

You will be returned to Figure 99.

To Test the Back-up Alarm, press the 'Test' button.

Note – This is a software test only.

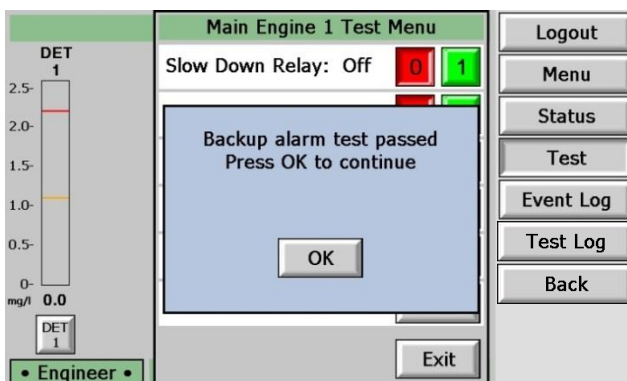


Figure 103 Screen Shot 58

Press 'OK'

You will be returned to Figure 99.

To Test the Optics, press the 'Test' button.

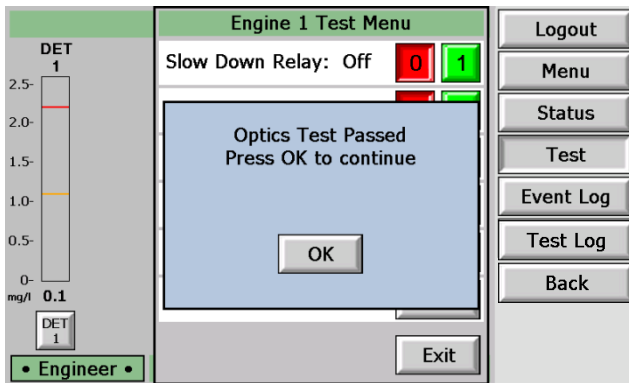


Figure 104 Screen Shot 59

Press 'OK'

You will be returned to Figure 99.

To Test the Front Panel, press the 'Test' button.

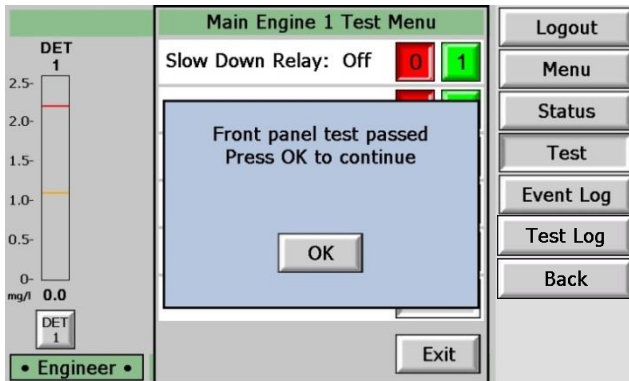


Figure 105 Screen Shot 60

Press 'OK'

You will be returned to Figure 99.

Press 'Exit' to return to Engine 1 overview shown in slide below.

Note - This will also reset all Tests.

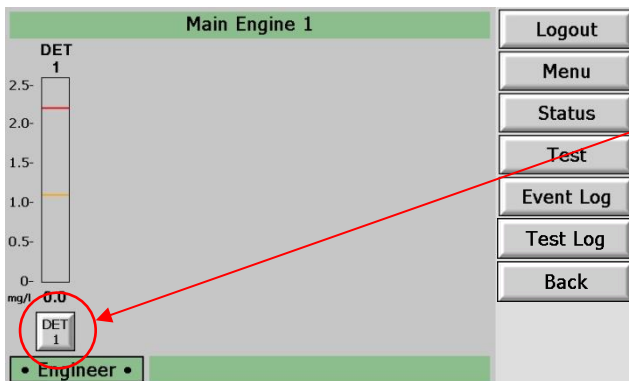


Figure 106 Screen Shot 61

For Testing of Detectors per engine, press the button under the mg/l display for the required Detector.

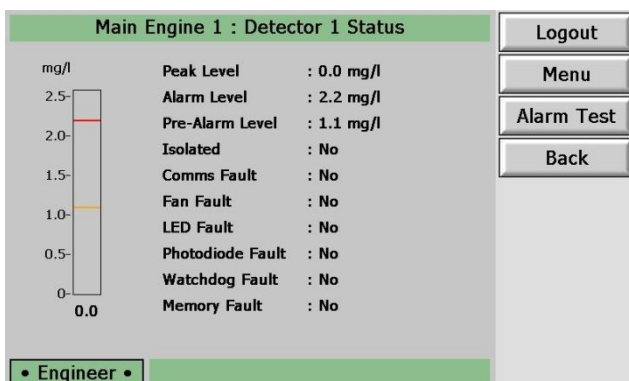
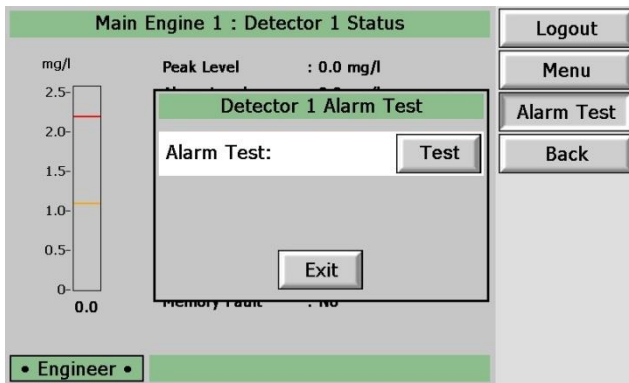


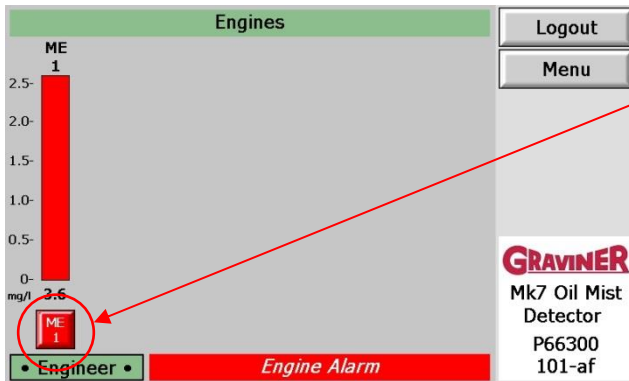
Figure 107 Screen Shot 62

Press 'Alarm Test'



Press 'Test'

Figure 108 Screen Shot 63



Press the button under the mg/l display for the required engine.

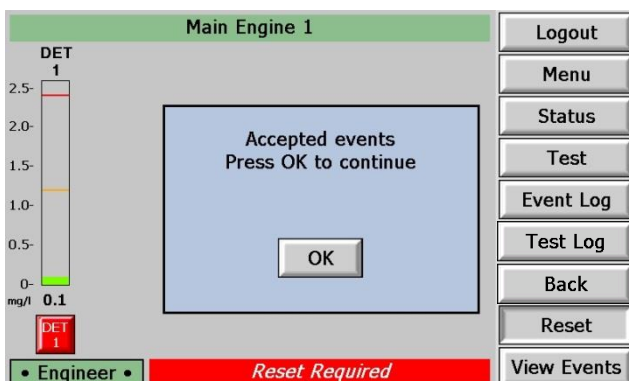
Note: The Control Unit and Detector tested will show 'Alarm' and display the current mg/l level measured by the Detector under test.

Figure 109 Screen Shot 64



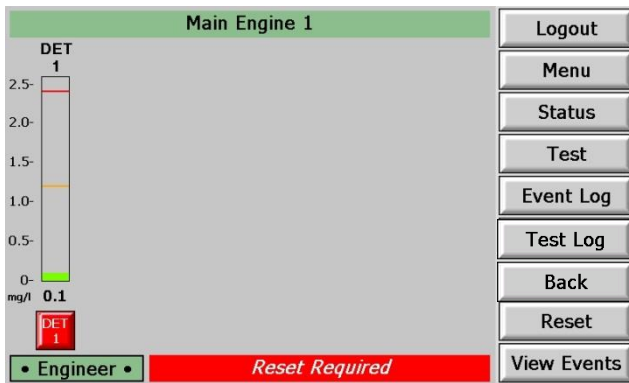
Press 'Accept'

Figure 110 Screen Shot 65



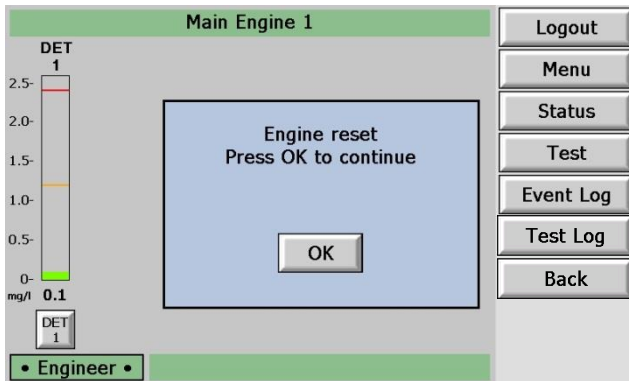
Press 'OK'

Figure 111 Screen Shot 66



Press 'Reset'

Figure 112 Screen Shot 67



Press 'OK'

You will now return to Figure 112.

Press the 'Back' button to return to Engine Overview, Figure 97.

Figure 113 Screen Shot 68

2.11.2 Event Log.

The Event Log enables the user to interrogate the past 1024 events and can be accessed via the menus below. The Event Log is a rolling buffer and when the events exceed 1024 then the oldest event is dropped off the Event Log.

To access the Event Log from Figure 98, press 'Event Log' button.

Main Engine 1 Event Log					
All Events By Date By Event By Detector					
No.	Date	Time	Event	Detector / Description	Value
530	07/07/11	11:20:26	System Reset		
529	07/07/11	11:19:59	Accept		
528	07/07/11	11:18:52	Alarm	Detector 1	3.6 mg/l
527	07/07/11	11:18:52	Pre-Alarm	Detector 1	3.6 mg/l
526	07/07/11	11:18:51	Alarm Test	Detector 1	
525	07/07/11	11:18:02	Front Panel Test		Passed
524	07/07/11	11:18:02	Supply Voltage		23.8v
523	07/07/11	11:17:51	System Reset		
522	07/07/11	11:17:49	Accept		
521	07/07/11	11:17:43	Photodiode Fault	Detector 1	

All log events will be displayed.

↑ ↓

Exit

Use the Up and Down arrows to scroll through the events in this screen.

Press 'By Date' tab to view event log by date.

Figure 114 Screen Shot 70

Engine 1 Event Log					
All Events By Date By Event By Detector					
Day Month Year					
Date: 18 / 07 / 11					
1	2	3	4	5	6
7	8	9	0	Del	
Search					
Exit					

Use the number buttons to select the date to view events.

Press 'Search' once the correct date is entered.

Figure 115 Screen Shot 71

Engine 1 Event Log					
All Events By Date By Event By Detector					
No.	Date	Time	Event	Detector / LED	Value
45	18/07/11	16:00:23	Front Panel Test		Passed
44	18/07/11	16:00:23	Supply Voltage		24.9v
43	18/07/11	16:00:21	System Test		
42	18/07/11	15:55:24	System Reset		
41	18/07/11	15:55:20	Accept		
40	18/07/11	15:55:16	Alarm	Detector 2	3.6 mg/l
39	18/07/11	15:55:16	Pre-Alarm	Detector 2	3.6 mg/l
38	18/07/11	15:55:16	Alarm Test	Detector 2	
37	18/07/11	15:53:02	System Reset		
36	18/07/11	15:53:00	Accept		

Hide Log

↑ ↓

Search

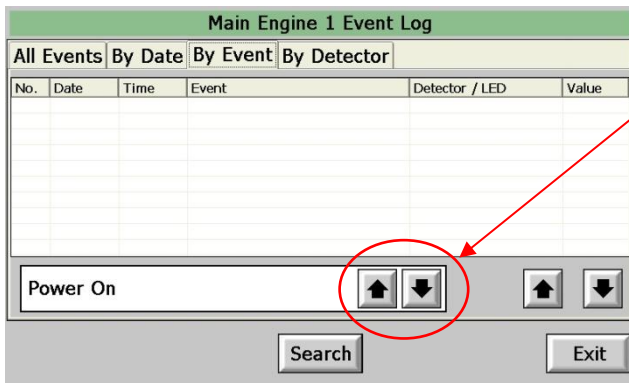
Exit

Use the Up and Down arrows to scroll through the events in this screen.

Press 'By Event' tab to view event log by Event.

Figure 116 Screen Shot 72

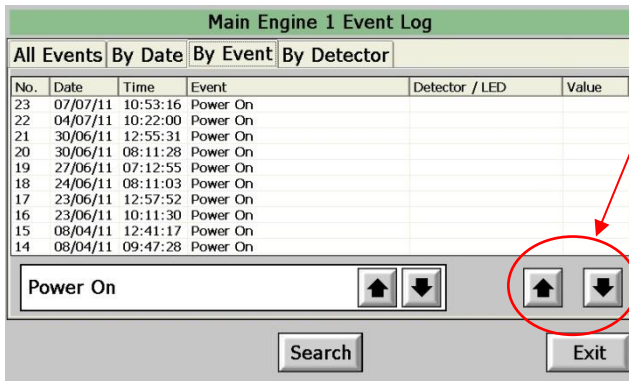
Note - If there are no Events matching your search then this screen will be blank.



Use the Up and Down arrows to select the event to search.

Press 'Search' to view event log by selected event.

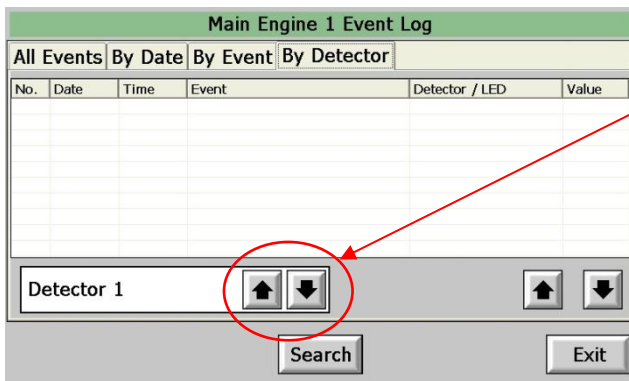
Figure 117 Screen Shot 73



Use the Up and Down arrows to scroll through the events in this screen.

Press 'By Detector' tab to view event log by Detector.

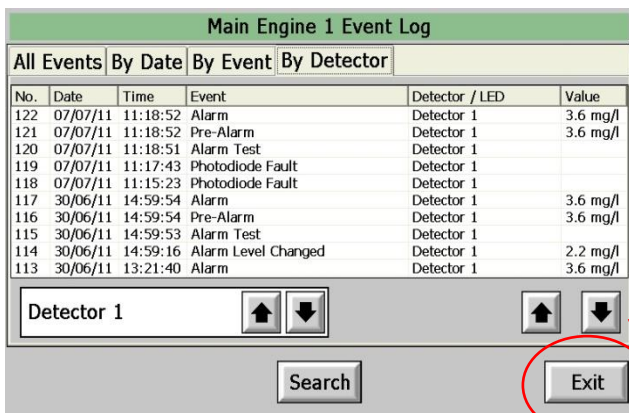
Figure 118 Screen Shot 74



Use the Up and Down arrows to select the Detector to search.

Press 'Search' to view event log by selected Detector.

Figure 119 Screen Shot 75



Use the Up and Down arrows to scroll through the events in this screen.

Press 'Exit' to return to Engine 1 overview, Figure 98.

Press 'Back' to return to Engines Overview screen. (Figure 97)

Figure 120 Screen Shot 76

2.11.3 Test Log.

The Test Log provides additional diagnostics and enables a user, logged in at the Engineer Level, to interrogate the past 1024 events and can be accessed via the menus below. The Test Log is a rolling buffer and when the events exceed 1024 then the oldest event is dropped off the Test Log.

To access the Test Log from Figure 98, press 'Test Log' button.

The screenshot shows a software interface titled "System Test Log: Thu, 06 Jan 2011" with a page indicator "1 of 1". Below the title is a table with the following data:

No	Name	Oil Mist/Volts	Peak Temp.	Peak Vib. X	Peak Vib. Y	Peak Vib. Z
	Engine Controller	0.0v	0 °C	0.0 g	0.0 g	0.0 g
1	Detector 1	0.0 mg/l	0 °C	0.0 g	0.0 g	0.0 g
2	Detector 2	0.0 mg/l	0 °C	0.0 g	0.0 g	0.0 g
3	Detector 3	0.0 mg/l	0 °C	0.0 g	0.0 g	0.0 g
4	Detector 4	0.0 mg/l	0 °C	0.0 g	0.0 g	0.0 g
5	Detector 5	0.0 mg/l	0 °C	0.0 g	0.0 g	0.0 g
6	Detector 6	0.0 mg/l	0 °C	0.0 g	0.0 g	0.0 g
7	Detector 7	0.0 mg/l	0 °C	0.0 g	0.0 g	0.0 g
8	Detector 8	0.0 mg/l	0 °C	0.0 g	0.0 g	0.0 g
9	Detector 9	0.0 mg/l	0 °C	0.0 g	0.0 g	0.0 g
10	Detector 10	0.0 mg/l	0 °C	0.0 g	0.0 g	0.0 g

Below the table is the GRAVINER logo in red, a navigation arrow pointing up, a navigation arrow pointing down, and an "Exit" button.

The Test Log screen displays the Input DC voltage measured by the selected Control Unit (Engine) or the current Oil Mist reading for a Detector.

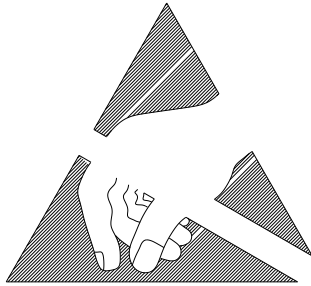
The diagnostic readings also include the **PEAK** Temperature and the **PEAK** vibration level (measured in the X, Y and Z axis) measured by each Detector on the selected Engine.

The readings are taken every 24 hours @ 16:00 hours during the automatic system test.

3 MAINTENANCE

3.1 ROUTINE MAINTENANCE

Warning: Do not work on the system unless the power is switched off or isolated.



ATTENTION
OBSERVE PRECAUTIONS
FOR HANDLING
ELECTROSTATIC
SENSITIVE
DEVICES

Caution: Ensure that anti static handling procedures are observed applied when working on the system, i.e. Anti- Static Wrist Straps

The following checks are recommended to be carried out every 6 months, with the system switched off. The checks should be carried out by competent personnel with suitable skill levels.

3.1.2 Control Unit

1. Ensure that all connectors are tight to prevent ingress of oil and moisture and the screws on the Control Unit are correctly tightened

3.1.3 Cables

1. Ensure all connections on the Control Unit are tight.
2. Check all cables. Replace any that are found to be damaged.

3.1.4 Detectors

1. Ensure that the Detector base is screwed tight into the crankcase,
2. Remove the cable connector from the Detector and check for damage.
3. Inspect and clean each Detector as defined in section 3.3 onwards.

3.2 DETECTOR HEAD REPLACEMENT

Warning: Do not remove the Detector base from the crankcase whilst the engine is in operation. This operation should be carried out while the engine is stopped to avoid the possibility of hot oil coming out of the base fixing hole.

If an in-service Detector head is removed for any reason, the Detector optics must be cleaned before reassembling and replacing it.

3.2.1 To replace the Detector:

1. Switch off the system (if safe to do so) or isolate the Detector
2. Remove the cable connector fitted to the top of the Detector
3. Using a 4mm hexagonal key, loosen the two fixing screws in the assembly base.



Figure 121 Base Fixing Screw Removal

4. Lift out the faulty Detector head
5. Fit the new Detector head onto its base and tighten up the fixing screws. Re-fit the cable to the Detector head.
6. If the system was switched off, switch back on and allow the system to initialise.
7. If isolated, then de-isolate the Detector, Press OK on the Remote Display Unit, display will then return to normal

3.3 DETECTOR HEAD REFURBISHMENT

1. Isolate the Detectors as described in section 2.10 of the instruction manual.
2. Disconnect the cable from the top of the Detector unit and remove the unit from the engine casing (refer to Figure 121).



Figure 122 Cable Disconnect

3. Using a 4mm hexagon key, unscrew 2 off screws from the underside of the Detector head (refer to Figure 121). The screws are self-retaining.
4. Remove and invert the top part of the Detector head. Examine the base moulding seal and replace if damaged or perished (refer to Figure 123).

Screw Removal

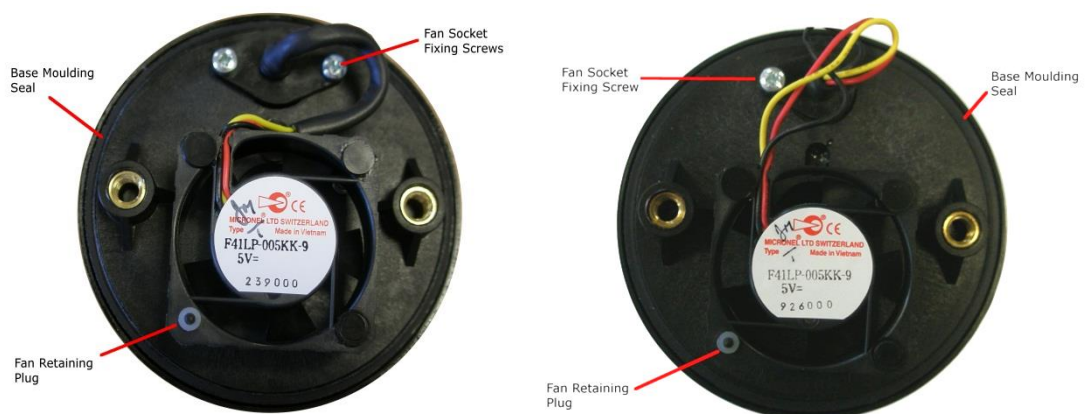


Figure 123 Base Moulding Seal

Caution: Do not press the fan, only handle the outer housing.

5. Using the Pulling Tool (refer to Figure 124), remove the Fan Retaining Plug by capturing the shoulder and pulling. Carefully remove the Fan from its mountings (refer to Figure 125).



Figure 124 Pulling Tool

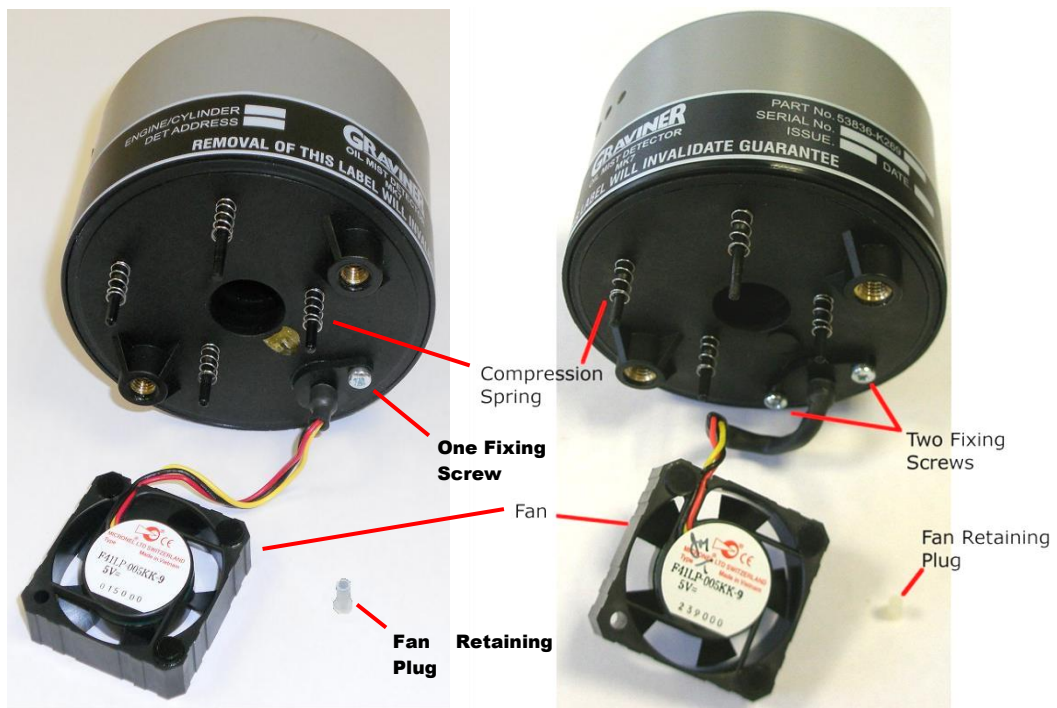


Figure 125 Fan Removal

6. Examine the 4 off compression springs and the fan retainer plug; replace any bent or damaged items from the spares.
7. Examine the fan for free running and clogging due to oil residues. If damaged, refer to paragraph 3.4 in the instruction manual. Although not necessary for service cleaning, spares of the M3 screw and the fan connector seal are included in the kit.
8. Using a foam bud with glass cleaner applied, wipe carefully around the inside of the smoke detecting orifice (refer to Figure 126).



Figure 126 Cleaning Light Guide

9. Dry the inside of the unit.
10. Examine the base body cavity and sampling tube, and wipe clean where necessary.
11. Reassemble the fan to the Detector using a fan retaining plug.

Caution: Do not press the centre label of the fan, only handle the fan by the outer housing.

12. Reassemble the Detector head and base body. Replace the Detector and then de-isolate.
13. Repeat the procedure for all Detectors to be cleaned.

Refer to the Materials Safety Data Sheet in the event of health or safety issues.

3.4 FAN REPLACEMENT

Warning: Do not remove the Detector base from the crankcase whilst the engine is in operation. This operation should be carried out while the engine is stopped to avoid the possibility of hot oil coming out of the base fixing hole.

3.4.1 To replace the fan:

1. Switch off the system (if safe to do so), or isolate the associated Detector.
2. Remove the cable connector from the top of the Detector.
3. Using a 4mm Allen key, loosen the Detector fixing screws on the base.
4. Remove the detector from its base and turn it upside down to reveal the fan.
5. Remove the fixing screw holding the fan socket to the mounting plate.
6. Using a pulling tool (Part Number 1-D9131-002 available with service kit Part No. 1-D9221-027), remove the fan retaining plug holding the fan onto its mounting legs.
7. Lift the fan off of its mounting legs, ensuring the springs under the fan are not lost.
8. Discard the failed fan and fit a replacement fan in reverse order of disassembly.

3.5 CABLE REPLACEMENT

If changing a Detector cable, isolating that Detector will be sufficient (see section 2.10)

3.5.1 Detector Cable

1. Isolate the Detector with the damaged cable.
2. Remove the cable connector on top of the Detector.
3. Identify the cable to be removed at the Control Unit
4. Unscrew the cable connector at the Detector and discard the damaged cable.
5. Connect the replacement cable to the connector on the Control Unit ensuring it is screwed in place.
6. Connect the cable connector to the Detector
7. De-isolate the Detector
8. Press OK on The Remote Display Unit

3.5.2 Power Supply Cable Replacement (Supplied by Others)

1. Switch off the system.
2. Disconnect the damaged power supply cable from the Control Unit or Remote Display Unit.
3. Connect the replacement power supply cable to the Control Unit or Remote Indicator Unit ensuring wires and cable screen are correctly fitted in the terminals.
4. Switch the system on and allow the system to initialise.

3.5.3 Communications Cable Replacement (Supplied by Others)

1. Switch off the system.
2. Disconnect the damaged communications cable from the Control Unit.
3. Disconnect the damaged communications cable from the Remote Display Unit or AMS.
4. Connect the replacement communications cable to the Control Unit ensuring it is screwed in place.
5. The replacement communications cable must be connected to the terminals in the Control Unit and the Remote Display Unit or AMS.
6. Switch the system on and allow it to initialise.

3.5.4 Control Unit (Pre-Alarm, Slowdown/Shutdown and Back-Up Alarm or Fault Relay Cable Replacement (Supplied by Others)

1. Switch off the system.
2. Remove the Control Unit Lid by removing the 4 screws
3. Disconnect the damaged relay cable from the Control Unit.
4. Disconnect the damaged relay cable from the monitoring equipment.
5. Connect the replacement relay cable to the Control Unit ensuring it is screwed in place.
6. Connect the replacement relay cable to the monitoring equipment.
7. Switch the system on and allow it to initialise.

3.6 CONTROL UNIT MEMBRANE

A new Control Unit Lid will be supplied fitted with the Membrane.

1. Unscrew the 4 screws to remove the Control Unit Lid
2. Disconnect the 2 ribbon cables connecting the Control Unit Lid to the main PCB.
3. Fit new lid in reverse

3.7 CONTROL UNIT PCB REPLACEMENT

1. Power down the system
2. Remove the 4 screws from the lid
3. Disconnect the ribbon cables
4. Remove the top half of the terminal blocks for the Communications Cables, Pre Alarm and High Alarm Cables and Fault Cables
5. Disconnect the Detector connectors (1 through to 10) – Push sides to release.
6. Remove the 4 screws at the corners of the PCB
7. Remove PCB
8. Fit new PCB in reverse order to the above

3.8 DECOMMISSIONING

All the components of the Graviner Mk7 OMD system must be disposed of as electrical/electronic equipment waste. i.e. using waste disposal methods in accordance with current local waste disposal regulations.

4 FAULT FINDING

4.1 GENERAL

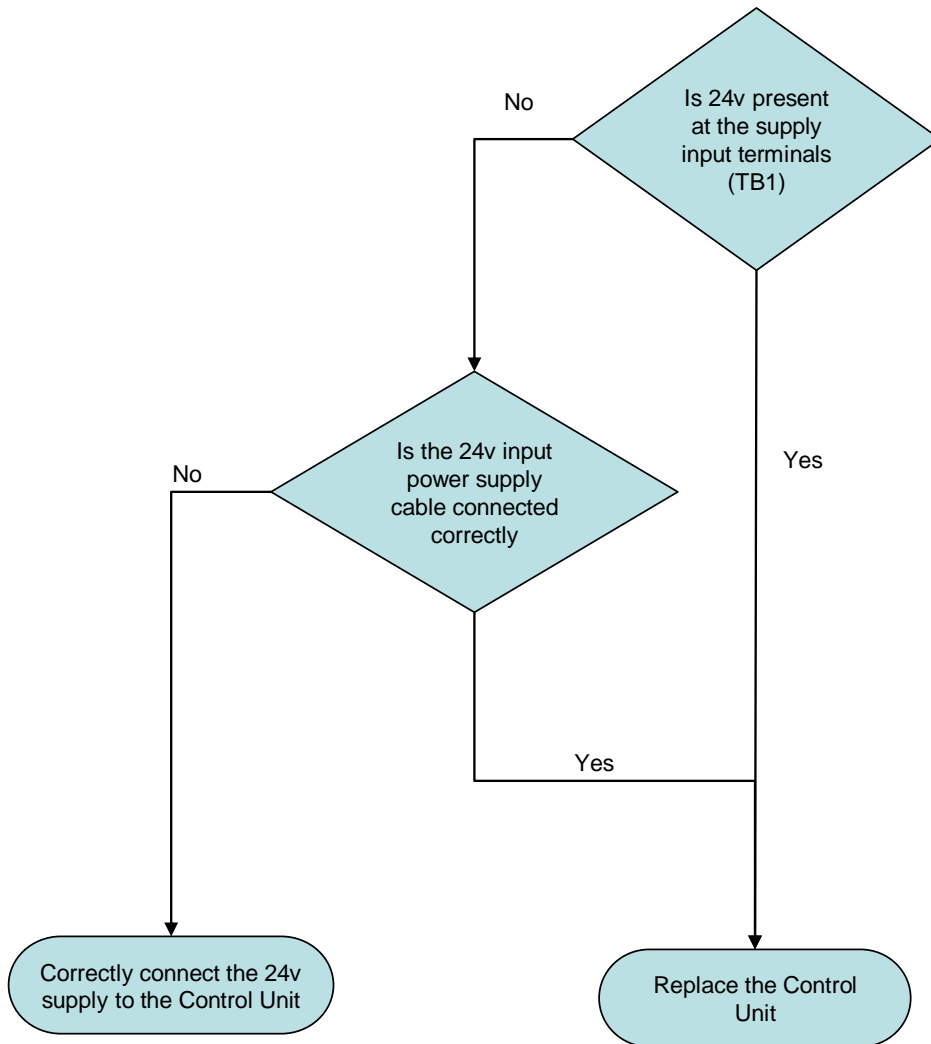
The table below lists a series of failure modes and the likely faults that would be indicated should that failure mode appear. Also listed are Actions, numbered 1 to 15, which should be followed if the associated fault appears. On the following pages, Actions 1 to 15 are shown as flow charts which will assist with fault finding on the Graviner Mk7 OMD system

Control Unit without a Remote Display			
Failure Mode	Fault Indication	Fault	Action
Control Unit Power indicator is off	All Control Unit LED's off	Supply Failure Membrane failure	1.
Control Unit fault	Control Unit fault LED on.	Control Unit fault	2.
All Detector Power On (Green) indicators on the Control Unit are off.	No indication on the Detectors. Control Unit fault LED on, all Detector fault LED's flashing 1sec on 1sec off	Control Unit fuse. Detectors disconnected.	3.
A Detector indicating communications fault	Detector fault LED on Control Unit fault LED on, all Detector fault LED flashing 1sec on 1sec off	Damaged detector cable Detector failure. Damaged Control Unit PCB	4.
Detector fault other than communications fault.	Detector fault LED on Control Unit fault LED on, all Detector fault LED flashing 0.5sec on 0.5sec off	Fan fault LED contamination fault Detector failure	5.
All Detector Power On (Green) indicators are off.	No indication on the detectors. Control Unit fault LED on, all Detector fault LED's flashing 1sec on 1sec off	Short circuit in Detector Cable Component Failure in Detector	13.

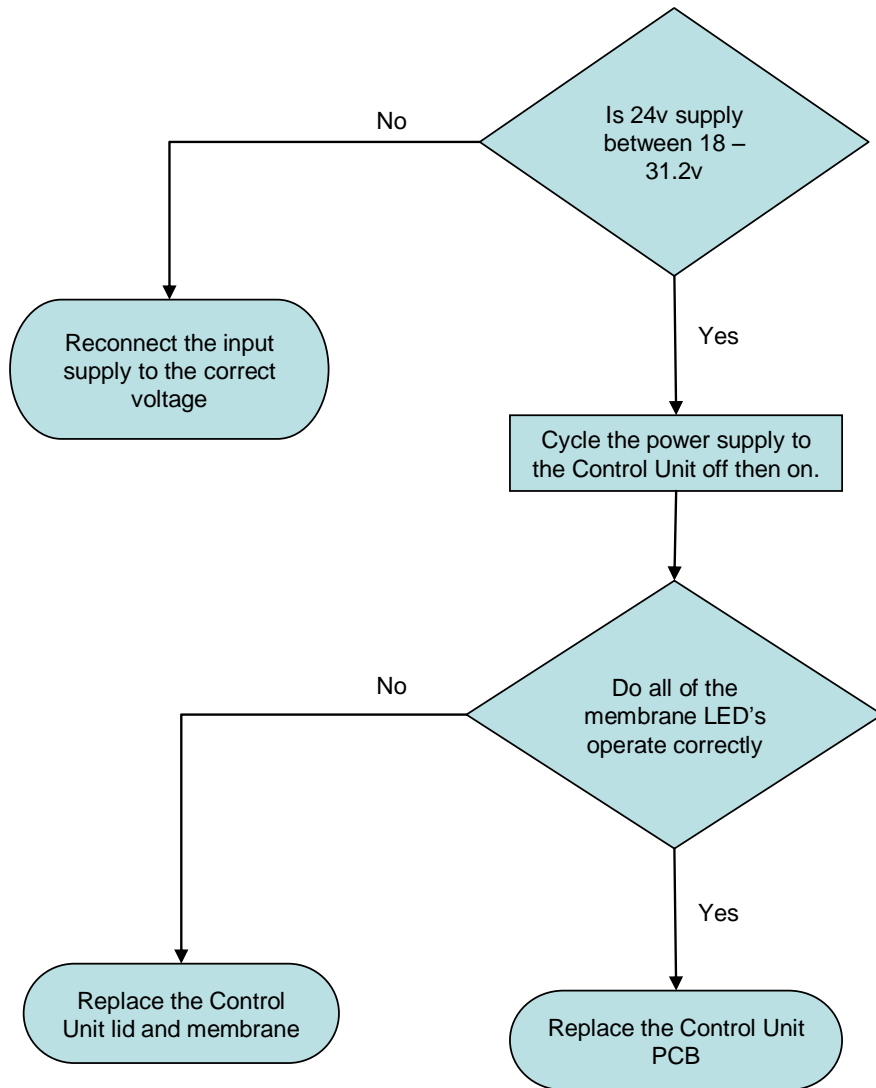
Control Unit with Remote Display			
Failure Mode	Fault Indication	Fault	Action
Control Unit Power indicator is off	All Control Unit LED's off Communications fault with the engine indicated on the Remote Display	Supply Failure	6.
Control Unit membrane fault	Control Unit fault LED on. Front panel test failed indicated on the Remote Display	Control Unit membrane fault Control Unit PCB fault	7.
Control Unit memory fault	Control Unit fault LED on. External RAM indicated on the Remote Display	Control Unit PCB fault	8.
Control Unit watchdog fault	Control Unit fault LED on. Watchdog fault indicated on the Remote Display	Control Unit PCB fault	8.
All Detector Power On (Green) indicators on the Control Unit are off.	No indication on the Detectors. Control Unit fault LED on, all Detector fault LED's flashing 1sec on 1sec off Remote Display indicates communications fault on all Detectors for that engine.	Detectors disconnected. Power Supply failure	3.
A Detector indicating communications fault	Detector fault LED on Control Unit fault LED on, all Detector fault LED flashing 1sec on 1sec off Remote Display indicates communications fault on one Detector	Damaged detector cable Detector failure. Damaged Control Unit PCB	4.
Detector fan fault.	Detector fault LED on Control Unit fault LED on, all detector fault LED flashing 0.5sec on 0.5sec off Remote Display indicates fan fault on a Detector	Fan fault	9.
Detector LED fault.	Detector fault LED on Control Unit fault LED on, all Detector fault LED flashing 0.5sec on 0.5sec off Remote Display indicates an LED fault on a Detector	Detector sample area requires cleaning. An LED has failed. Detector failure.	10.
Detector LED fault.	Detector fault LED on	Detector sample area	10.

Control Unit with Remote Display			
Failure Mode	Fault Indication	Fault	Action
	Control Unit fault LED on, all Detector fault LED flashing 0.5sec on 0.5sec off Remote Display indicates a photodiode fault on a Detector	requires cleaning. Detector failure.	
Detector watchdog fault.	Detector fault LED on Control Unit fault LED on, all Detector fault LED flashing 0.5sec on 0.5sec off Remote Display indicates a watchdog fault on a Detector	Detector software has reset	11
Remote Display indicates a communications fault on all engines	Remote Display indicates a communications fault on all engines	Modbus communications cable fault End of line termination incorrect. Remote Display failure	12
All Detector Power On (Green) indicators are off.	No indication on the Detectors. Control Unit fault LED on, all Detector fault LED's flashing 1sec on 1sec off Remote Display indicates communications fault on all Detectors for that engine.	Short circuit in Detector Cable Component Failure in Detector	13
No communications between a single engine and the Display Unit.	Engine oil mist bar graph shown crossed out on the display.	Control Unit incorrectly addressed. Communications cable wiring incorrect. Modbus end of line jumpers incorrect.	14.
No communications between multiple consecutive engines and the Display Unit.	Multiple consecutive engine oil mist bar graphs shown crossed out on the display.	Control Unit(s) incorrectly addressed. Communications cable wiring incorrect.	15.

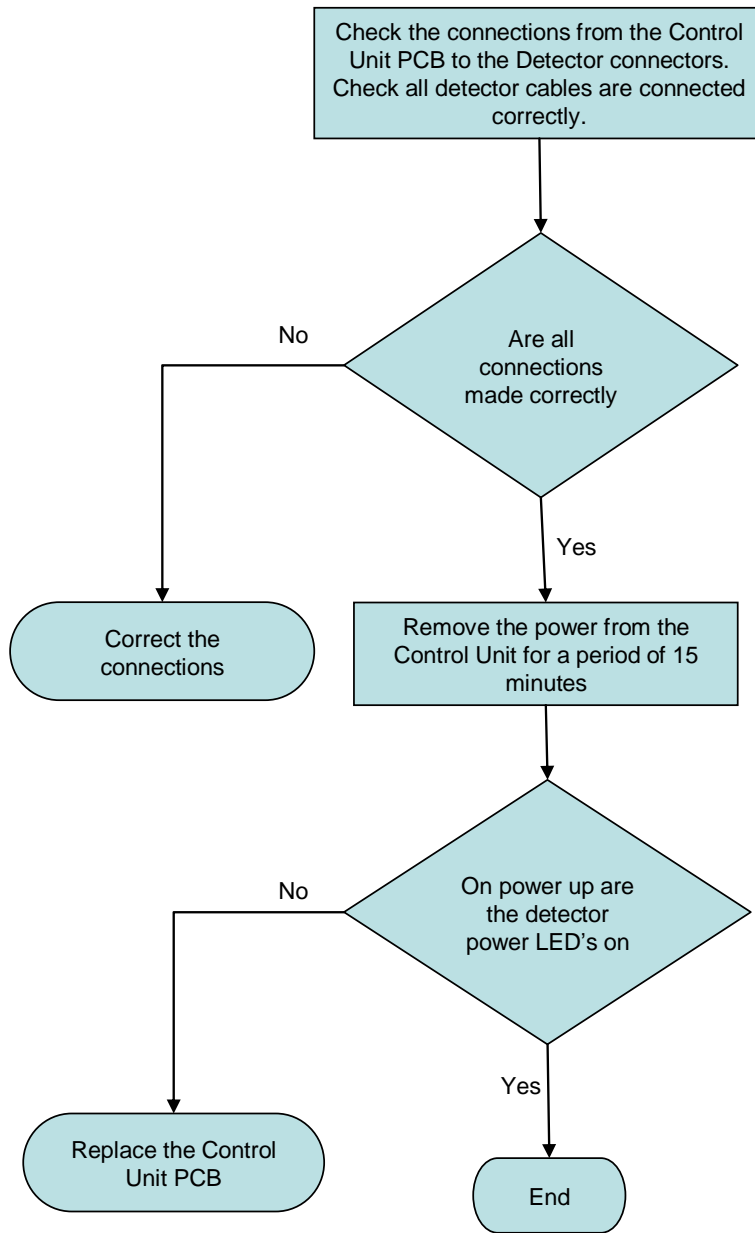
Action 1



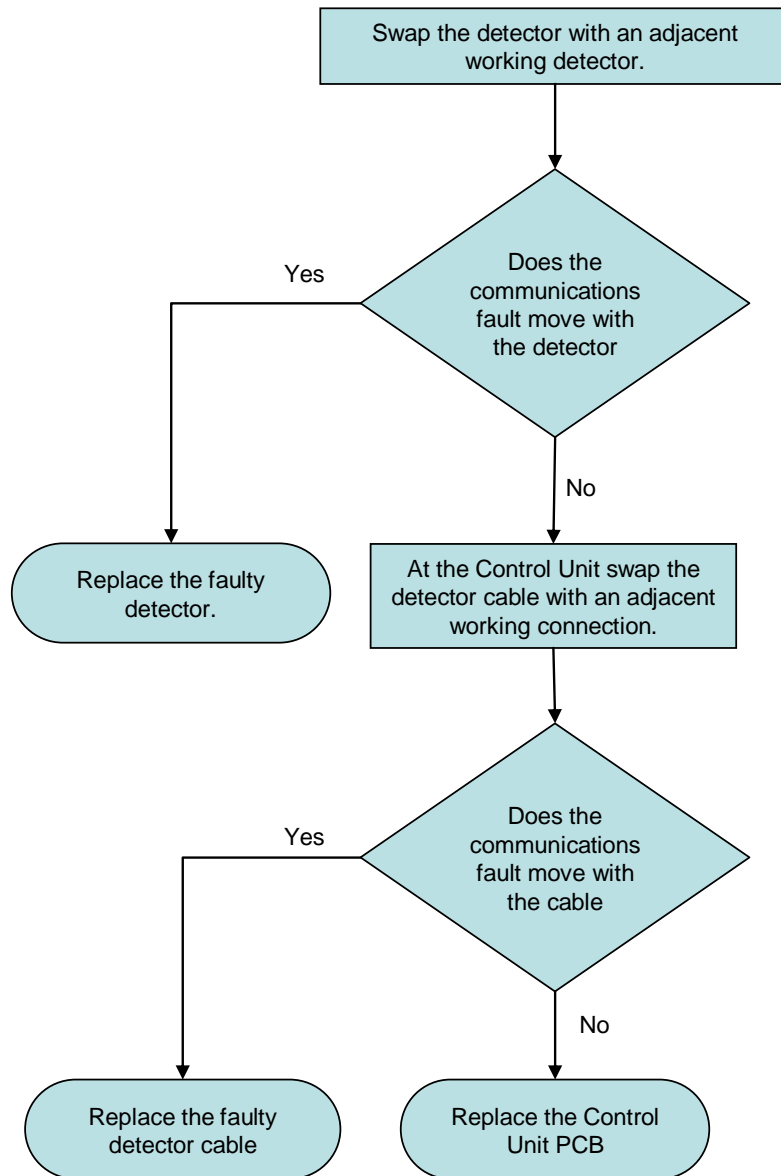
Action 2



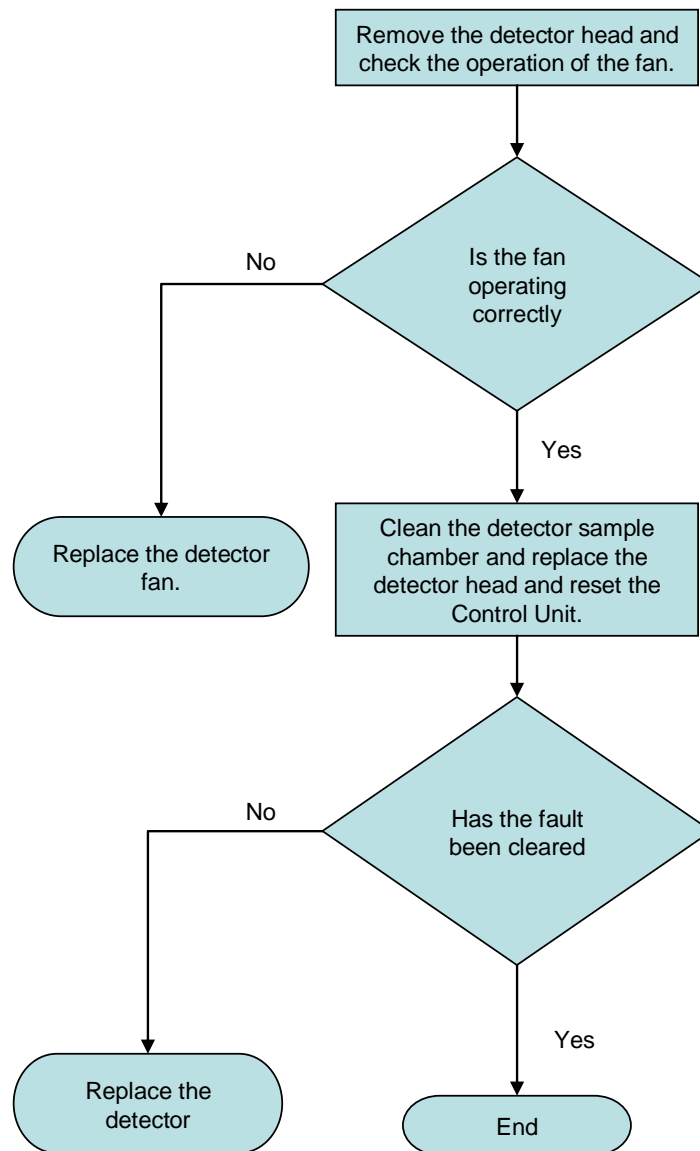
Action 3



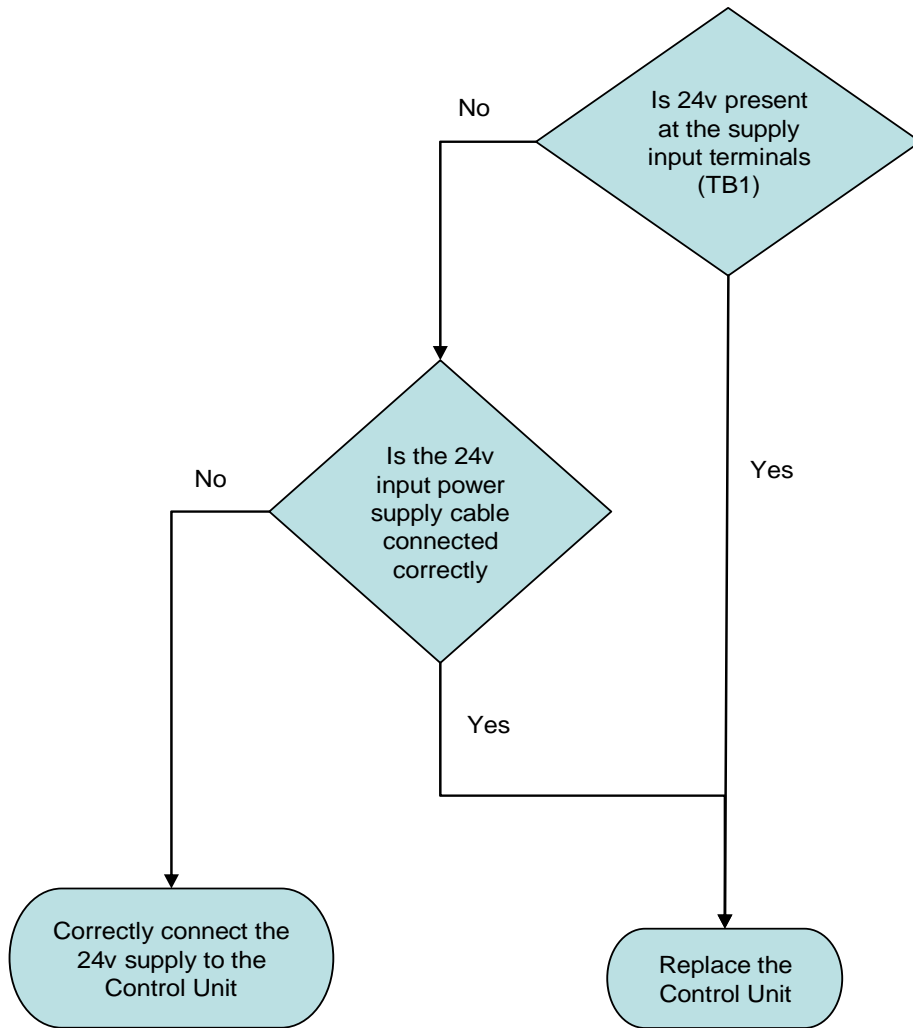
Action 4



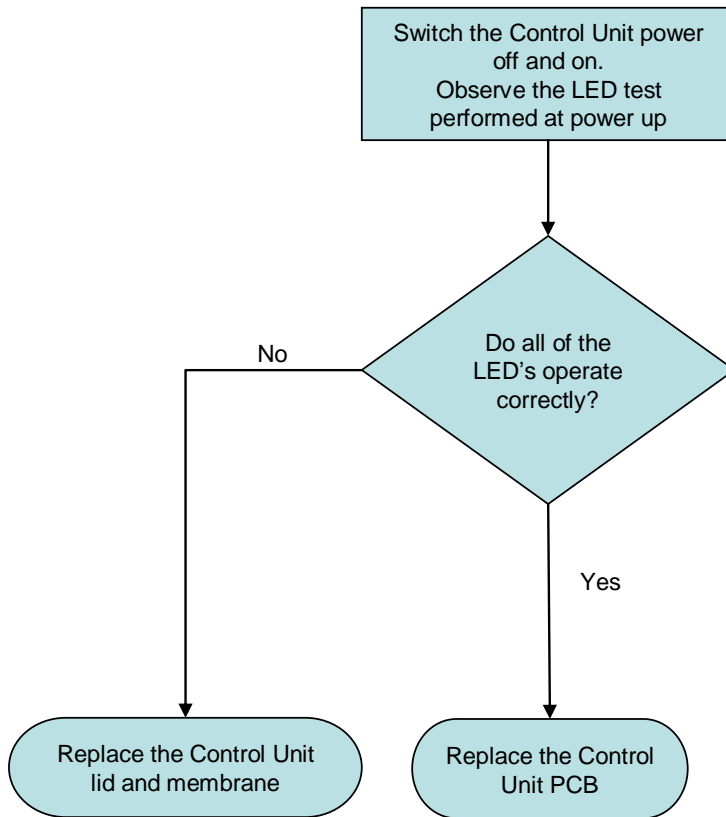
Action 5



Action 6



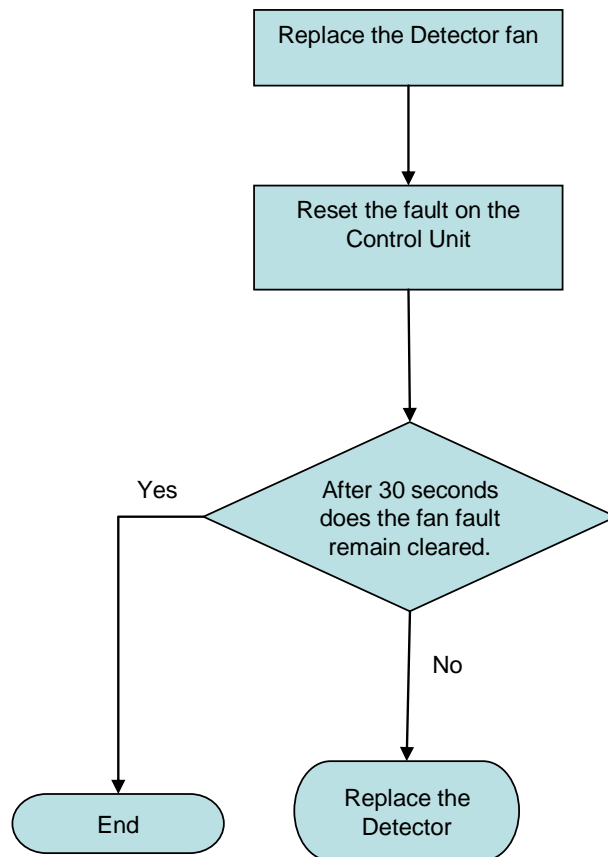
Action 7



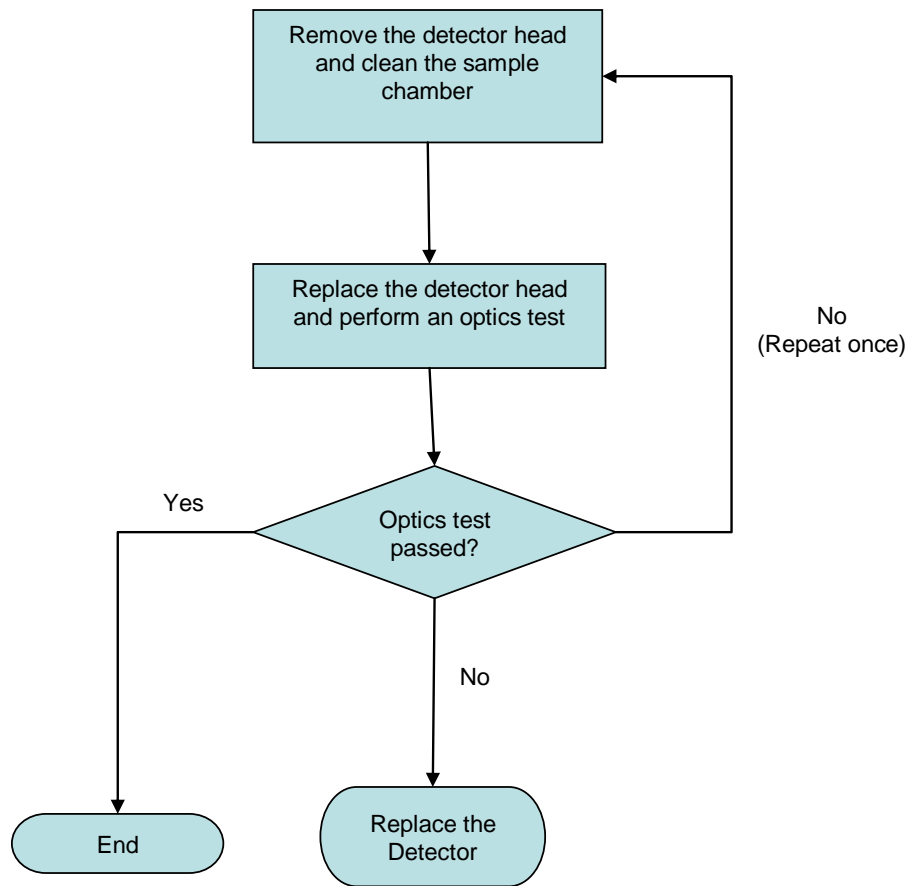
Action 8

Replace the
Control Unit
PCB

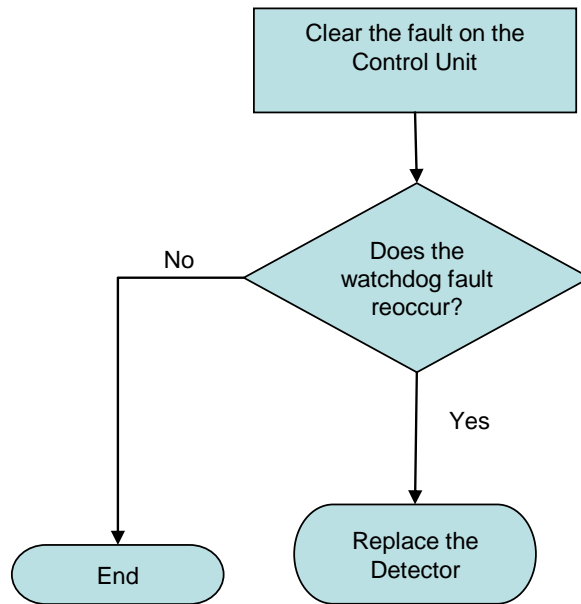
Action 9



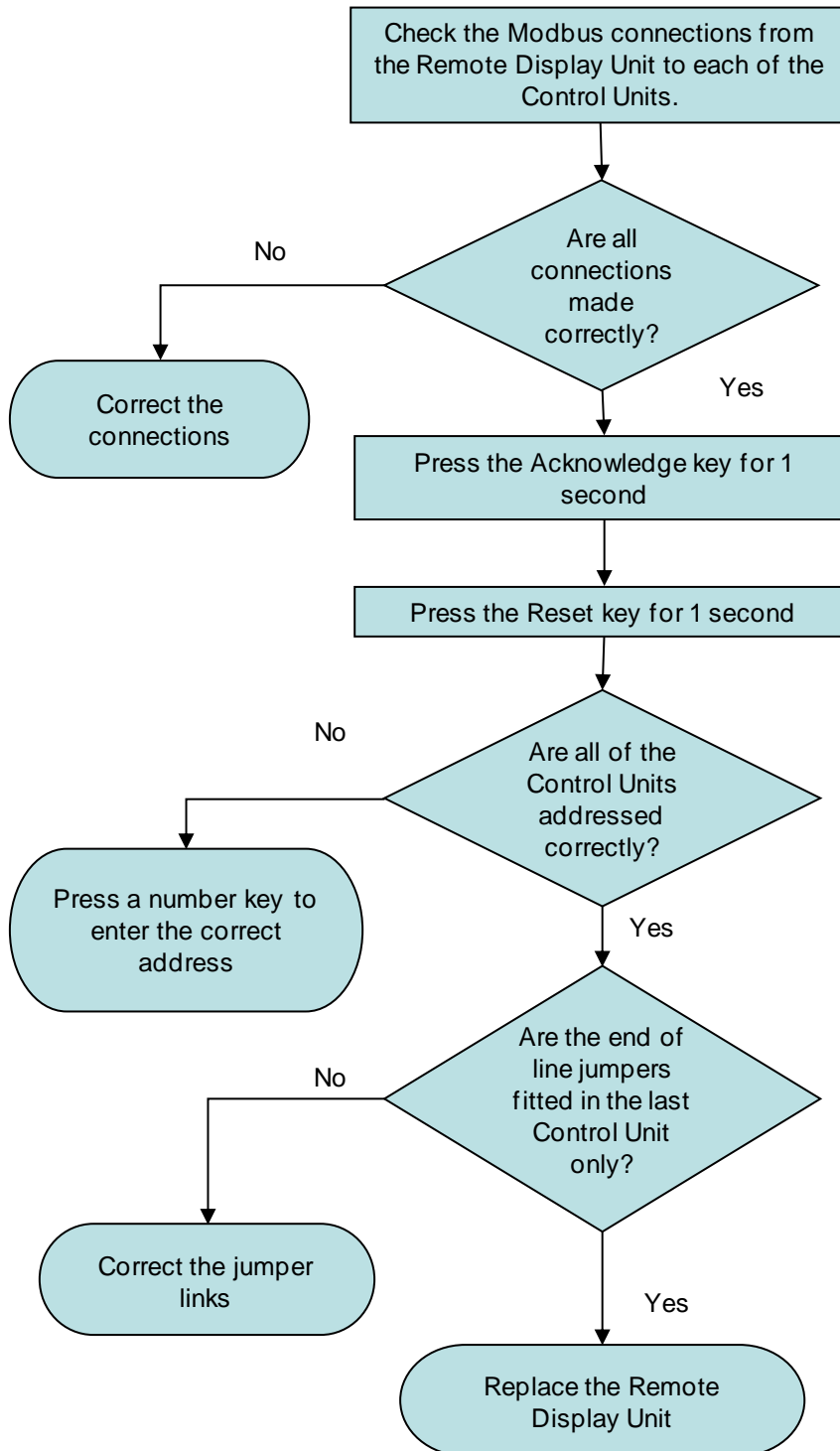
Action 10



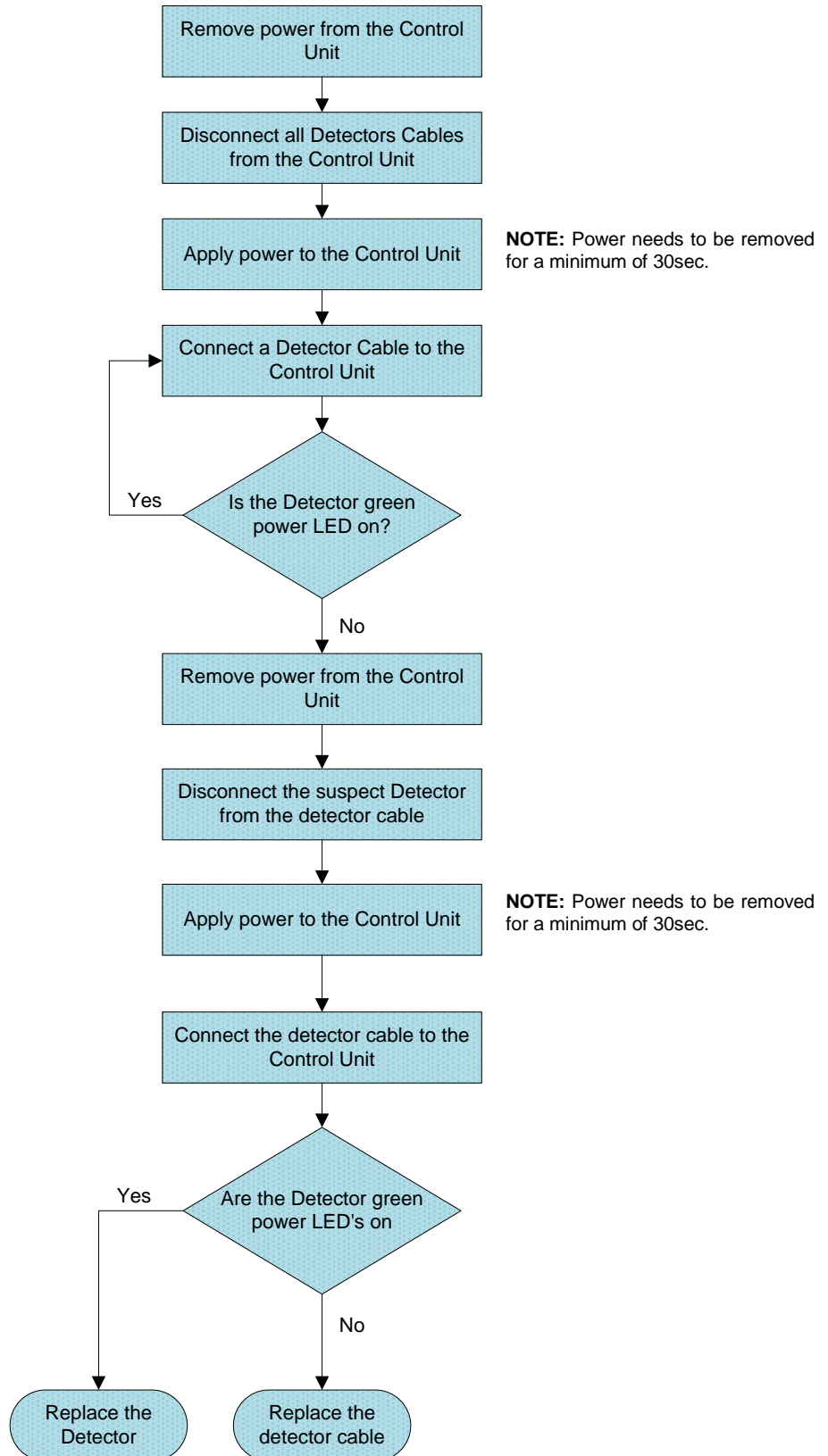
Action 11



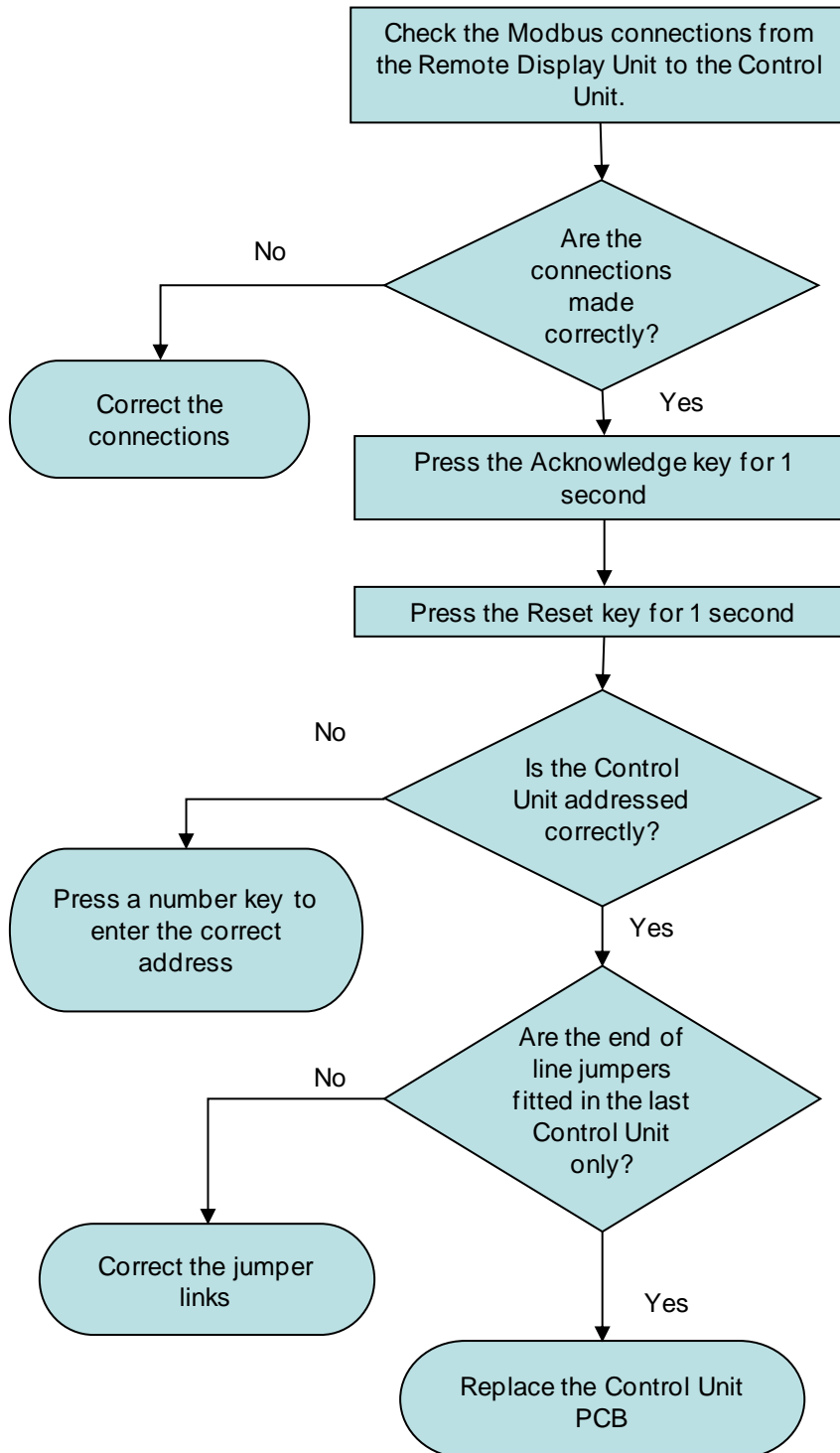
Action 12



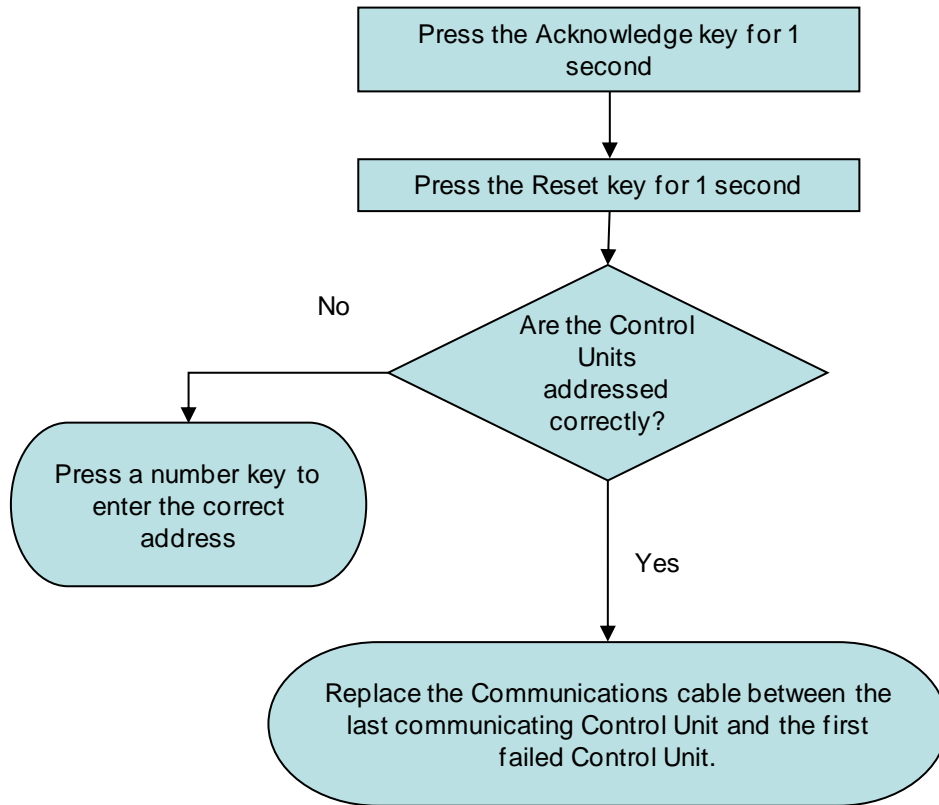
Action 13



Action 14



Action 15



SPARE PARTS

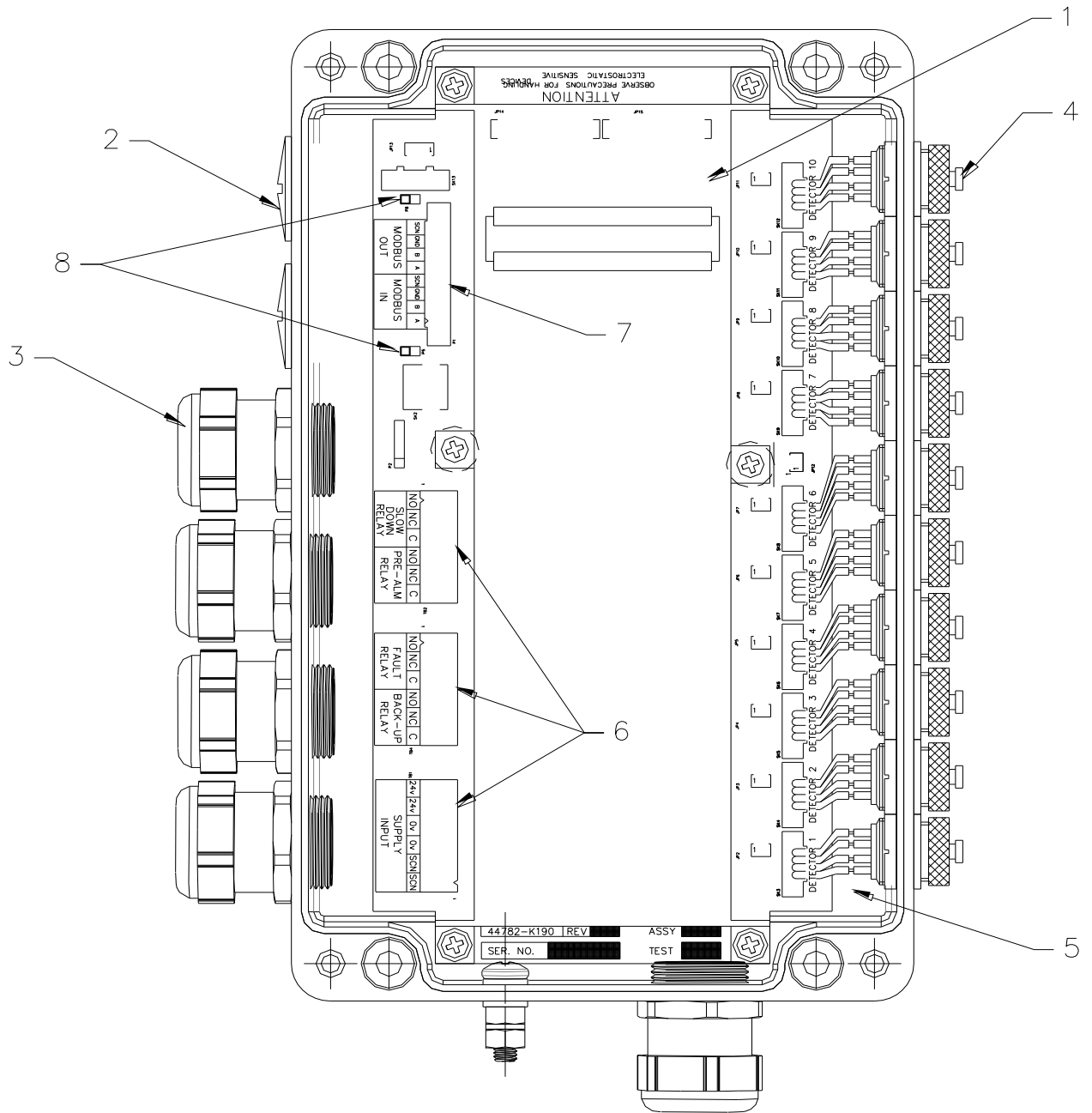


Figure 127 Control Unit Spares
(Refer page 93 for listing)

Control Unit Spares		
Item	Description	Part No.
	Control Unit with Membrane	1-53836-K270
	Control Unit with Membrane (Caterpillar)	1-53636-K270-01
	Control Unit without Membrane	1-53836-K276
1.	Printed Circuit Board c/w Ribbon Cables	1-43782-K172-00
1.	Printed Circuit Board w/out Ribbon Cables	1-43782-K172-01
1.	Printed Circuit Board c/w Ribbon Cables (Caterpillar)	1-44782-K190-01
2.	25mm Blanking Plug	1-22540-K029
3.	Metal Gland	1-22540-K028
4.	Detector Connection Cap	1-27400-K303
	Detector Harness Kit	1-53569-K003
5.	6 Way Detector Connection – Qty 1	
	Wrench Tool – Qty 1	
	Control Unit Connector Kit	1-53569-K004
6.	Relay & Power Plugs – Qty 3	
7.	Modbus Plug – Qty 1	
8.	EOL Jumpers – Qty 2	

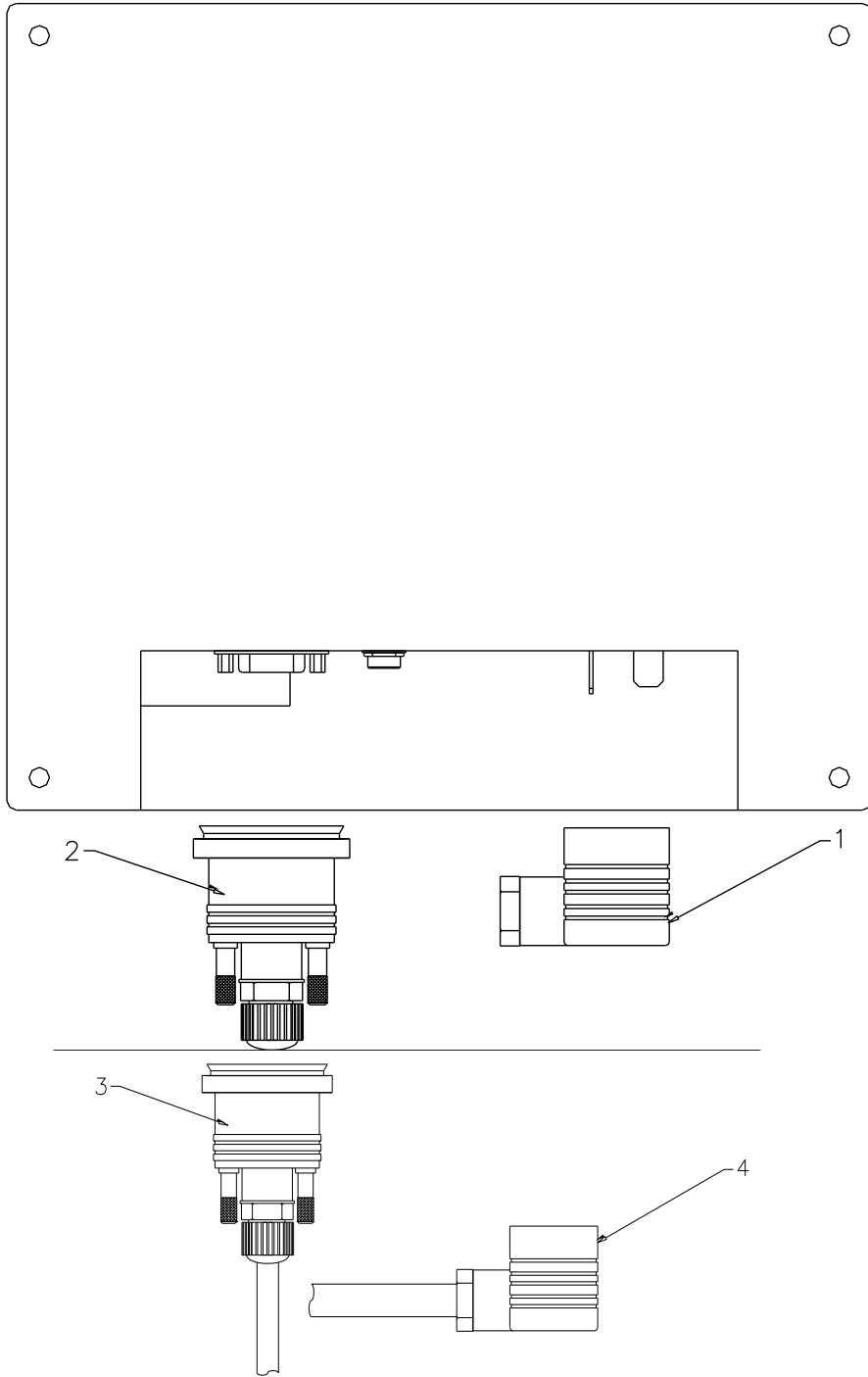


Figure 128 Display Unit Spares

Remote Display Unit Spares		
Item	Description	Part No.
	Remote Display Unit	1-53836-K271
1.	24VDC Power Socket (no Cable)	1-27400-K304
2.	Modbus Connector (no Cable)	1-27400-K305
3.	Modbus Connector c/w 5m Cable	1-43682-K297
4.	24VDC Power Socket c/w 5m Cable	1-43682-K296

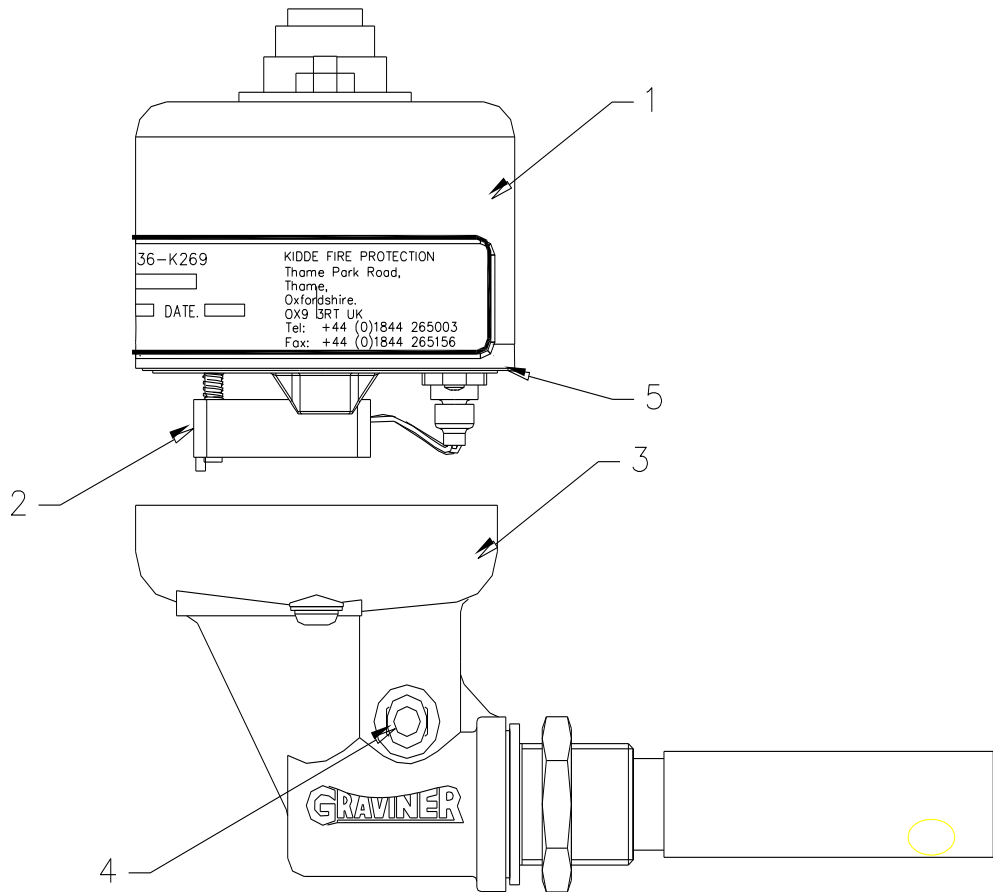


Figure 129 Detector Spares

Detector Spares		
Item	Description	Part No.
	Detector Complete	1-53836-K269
	Detector Complete (Short Sample Pipe)	1-53836-K269-01
1	Detector Head Assembly	1-53836-K272
2	Fan Assembly (1 Screw)	1-D5622-005-02
	Fan Assembly (2 Screw)	1-53569-K005
3	Base Unit sub-Assembly	1-D5622-101
4	Connector Push In	1-21888-K073
5	Base moulding O Ring	1-C1513-802

Commissioning Kit D9221-026 consists of:			
Description	Part No.	Qty	Category
Wipes, Wet & Dry	1-A7311-001	2	Consumables
Smoke Test Oil -30 ml	1-D9221-028	1 Bottle	Consumables
Wick - 150 mm	1-17100-H06	3	Consumables
Smoke Tester	1-D9221-029	1	Tools
Materials Safety Data Sheet	-	2	Information

Service Kit D9221-027 consists of:			
Description	Part No	Qty	Category
Fan Retainer	1-B3741-902	5	Spares
Compression Spring	1-B3721-006	5	Spares
Base Moulding Seal	1-C1513-802	5	Spares
Fan Connector Seal (1 Screw)	1-C1413-801	5	Spares
Fan Connector Seal (2 Screw)	1-35134-K037	5	Spares
M3 Screw	1-21833-H01	5	Spares
Glass Cleaner 500ml	1-A7311-002	1	Consumables
Foam Buds Pkts	1-B6910-217	2	Consumables
4mm Hexagon Key	1-B691 0-219	2	Tools
Pulling Tool	1-D9131-002	1	Tools
Materials Safety Data Sheet	-	2	Information

Recommended Operational Spares			
Description	Part No.	Qty	
Commissioning Kit	1-D9221-026	1	
Service Kit	1-D9221-027	1	
For systems with more than 10 detectors, it is recommended that additional detector head assemblies (1-53836-K272) are supplied.			

4.2 COMPLETE SPARE PARTS LIST

Part No.	Description	
1-53836-K270	Control Unit with Membrane for 10 detectors	
1-53836-K270-01	Control Unit with Membrane for 10 detectors	Caterpillar
1-53836-K276	Control Unit without Membrane for 10 detectors	
1-53836-K271	Touch Screen Display Unit	
1-53836-K269	Detector Complete	
1-53836-K269-01	Detector Complete (Short Sample pipe)	
1-53836-K279	Oil Mist Manager Software and Dongle	
	Cable Assemblies	
	90° Connector	
1-43682-K285-1.0	1.0m Cable with 90° Connector	1.0 Metres
1-43682-K285-1.5	1.5m Cable with 90° Connector	1.5 Metres
1-43682-K285-2.0	2.0m Cable with 90° Connector	2.0 Metres
1-43682-K285-2.5	2.5m Cable with 90° Connector	2.5 Metres
1-43682-K285-3.0	3.0m Cable with 90° Connector	3.0 Metres
1-43682-K285-3.5	3.5m Cable with 90° Connector	3.5 Metres
1-43682-K285-4.0	4.0m Cable with 90° Connector	4.0 Metres
1-43682-K285-4.5	4.5m Cable with 90° Connector	4.5 Metres
1-43682-K285-5.0	5.0m Cable with 90° Connector	5.0 Metres
1-43682-K285-5.5	5.5m Cable with 90° Connector	5.5 Metres
1-43682-K285-6.0	6.0m Cable with 90° Connector	6.0 Metres
1-43682-K285-6.5	6.5m Cable with 90° Connector	6.5 Metres
1-43682-K285-7.0	7.0m Cable with 90° Connector	7.0 Metres
1-43682-K285-7.5	7.5m Cable with 90° Connector	7.5 Metres
1-43682-K285-8.0	8.0m Cable with 90° Connector	8.0 Metres
1-43682-K285-8.5	8.5m Cable with 90° Connector	8.5 Metres
1-43682-K285-9.0	9.0m Cable with 90° Connector	9.0 Metres
1-43682-K285-9.5	9.5m Cable with 90° Connector	9.5 Metres
1-43682-K285-10.0	10.0m Cable with 90° Connector	10.0 Metres
1-43682-K285-10.5	10.5m Cable with 90° Connector	10.5 Metres
1-43682-K285-11.0	11.0m Cable with 90° Connector	11.0 Metres
1-43682-K285-11.5	11.5m Cable with 90° Connector	11.5 Metres
1-43682-K285-12.0	12.0m Cable with 90° Connector	12.0 Metres
1-43682-K285-12.5	12.5m Cable with 90° Connector	12.5 Metres
1-43682-K285-15.0	15.0m Cable with 90° Connector	15.0 Metres
1-43682-K285-17.5	17.5m Cable with 90° Connector	17.5 Metres
1-43682-K285-20.0	20.0m Cable with 90° Connector	20.0 Metres
1-43682-K285-22.5	22.5m Cable with 90° Connector	22.5 Metres
1-43682-K285-25.0	25.0m Cable with 90° Connector	25.0 Metres
1-43682-K285-27.5	27.5m Cable with 90° Connector	27.5 Metres
1-43682-K285-30.0	30.0m Cable with 90° Connector	30.0 Metres
1-43682-K285-32.5	32.5m Cable with 90° Connector	32.5 Metres
1-43682-K285-35.0	35.0m Cable with 90° Connector	35.0 Metres

Part No.	Description	
	Straight Connector	
1-43682-K286-1.0	1.0m Cable with Straight Connector	1.0 Metres
1-43682-K286-1.5	1.5m Cable with Straight Connector	1.5 Metres
1-43682-K286-2.0	2.0m Cable with Straight Connector	2.0 Metres
1-43682-K286-2.5	2.5m Cable with Straight Connector	2.5 Metres
1-43682-K286-3.0	3.0m Cable with Straight Connector	3.0 Metres
1-43682-K286-3.5	3.5m Cable with Straight Connector	3.5 Metres
1-43682-K286-4.0	4.0m Cable with Straight Connector	4.0 Metres
1-43682-K286-4.5	4.5m Cable with Straight Connector	4.5 Metres
1-43682-K286-5.0	5.0m Cable with Straight Connector	5.0 Metres
1-43682-K286-5.5	5.5m Cable with Straight Connector	5.5 Metres
1-43682-K286-6.0	6.0m Cable with Straight Connector	6.0 Metres
1-43682-K286-6.5	6.5m Cable with Straight Connector	6.5 Metres
1-43682-K286-7.0	7.0m Cable with Straight Connector	7.0 Metres
1-43682-K286-7.5	7.5m Cable with Straight Connector	7.5 Metres
1-43682-K286-8.0	8.0m Cable with Straight Connector	8.0 Metres
1-43682-K286-8.5	8.5m Cable with Straight Connector	8.5 Metres
1-43682-K286-9.0	9.0m Cable with Straight Connector	9.0 Metres
1-43682-K286-9.5	9.5m Cable with Straight Connector	9.5 Metres
1-43682-K286-10.0	10.0m Cable with Straight Connector	10.0 Metres
1-43682-K286-10.5	10.5m Cable with Straight Connector	10.5 Metres
1-43682-K286-11.0	11.0m Cable with Straight Connector	11.0 Metres
1-43682-K286-11.5	11.5m Cable with Straight Connector	11.5 Metres
1-43682-K286-12.0	12.0m Cable with Straight Connector	12.0 Metres
1-43682-K286-12.5	12.5m Cable with Straight Connector	12.5 Metres
1-43682-K286-15.0	15.0m Cable with Straight Connector	15.0 Metres
1-43682-K286-17.5	17.5m Cable with Straight Connector	17.5 Metres
1-43682-K286-20.0	20.0m Cable with Straight Connector	20.0 Metres
1-43682-K286-22.5	22.5m Cable with Straight Connector	22.5 Metres
1-43682-K286-25.0	25.0m Cable with Straight Connector	25.0 Metres
1-43682-K286-27.5	27.5m Cable with Straight Connector	27.5 Metres
1-43682-K286-30.0	30.0m Cable with Straight Connector	30.0 Metres
1-43682-K286-32.5	32.5m Cable with Straight Connector	32.5 Metres
1-43682-K286-35.0	35.0m Cable with Straight Connector	35.0 Metres

Part No.	Description	
	Spare Parts	
1-17100-H06	Cotton Wick (1 hank = 10 meters)	
1-21833-H01	M3 screw	
1-21888-K073	Connector Push in	
1-22540-K028	Metal Gland	
1-22540-K029	25mm Blanking Plug	
1-27400-K303	Detector Connection Cap	
1-27400-K304	24VDC Power Socket (no Cable)	
1-27400-K305	Modbus Connector (no Cable)	
1-35100-K274	Mk5 - Mk7 Retrofit Plate	
1-35134-K037	Fan Connector Seal (2 Screw)	
1-43682-K296	24VDC Power Socket c/w 5m Cable	
1-43682-K297	Modbus Connector c/w 5m Cable	
1-43782-K172-00	Printed Circuit Board c/w Ribbon Cables	
1-43782-K172-01	Printed Circuit Board w/out Ribbon Cables	
1-53569-K003	Detector Harness Kit	
	Incl 1 x 6Way Detector Connection	
	Incl 1 x Wrench Tool	
1-53569-K004	Control Unit Connector Kit	
	Incl 3 x Relay & Power Plugs	
	Incl 1 x Modbus Plug	
	Incl 2 x EOL Jumpers	
1-53569-K005	Fan, Micronel type (2 Screw)	
1-53836-K272	Mk7 Detector Head Assembly	
	Incl 1 x 1-53569-K005	
	Incl 1 x 1-C1513-802	
1-A7311-001	Wet Wipes	
1-A7311-002	Glass Cleaner 500ml	
1-B3721-006	Compression spring	
1-B3741-902	Fan Retainer	
1-B6910-217	Foam Buds Pkts	
1-B6910-219	4mm Hex Key	
1-C1413-801	Fan Connector Seal (1 Screw)	
1-C1513-802	Base moulding O ring	
1-D5622-005-02	Fan, Micronel type (1 Screw)	
1-D5622-101	Base unit sub assy	
	Incl 1 x 1-21888-K073	
1-D5622-102	Base unit sub assy – Short Sample Pipe	
	Incl 1 x 1-21888-K073	
1-D9131-002	Pulling tool	
1-D9221-026	Commissioning Kit	
1-D9221-027	Service Kit	
1-D9221-028	Smoke Oil	
1-D9221-029	Smoke tester	

SECTION 6
CATERPILLAR DETECTORS

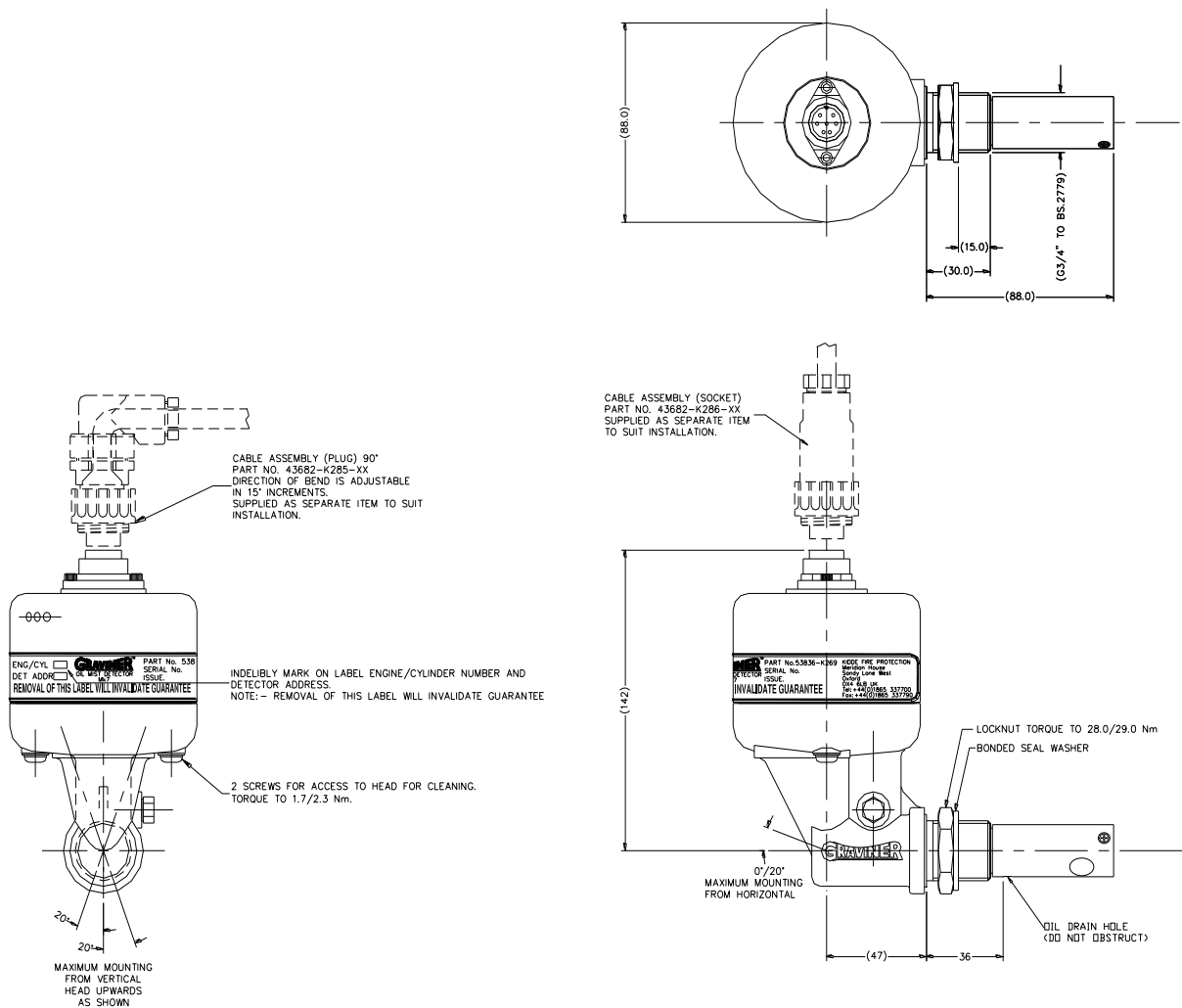


Figure 130 Caterpillar Detector with Short Sample Pipe Part Number 1-53836-K269-03

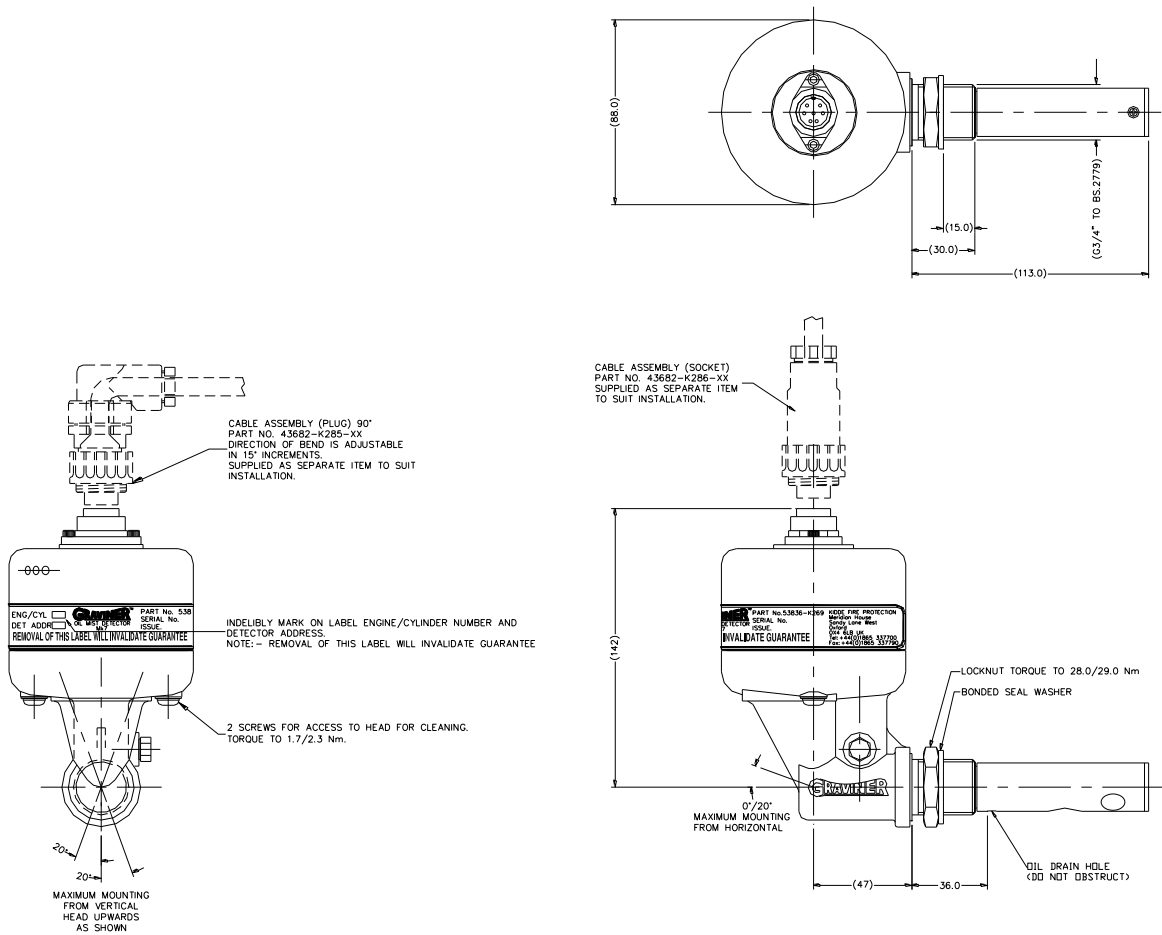


Figure 131 Caterpillar Detector with Standard Sample Pipe Part Number 1-53836-K269-02