

# PRODUCT OVERVIEW

## Automatic lubricators



**simalube**<sup>®</sup>  
smart lubrication

# simalube

Advantages of automatic lubrication with simalube	3
simalube – the lubrication expert	4/5
simalube 15 ml	6
simalube multipoint	7
simalube IMPULSE	8/9
Applications	10/11
Standard lubricants	12
Accessories	13/14/15



## simalube: continuous lubrication ensures low costs and high reliability

Millions of simalube lubricators are used worldwide in every industry. They are the best and most economical solution for the continuous supply of grease or oil for periods of up to one year.

**simalube – everywhere forces act, something spins or something moves.**



*Tom Maintain*

**Because my bearings are worth it!**

«Once installed, simalube lubricators lubricate evenly, accurately and reliably. This is not at all possible with manual lubrication.»

# Advantages of automatic lubrication with simalube

simalube lubricators replace costly manual lubrication. This not only saves time, but also prevents insufficient or over-lubrication. The costs can thus be reduced by up to 30 percent.

## Optimized lubricant delivery

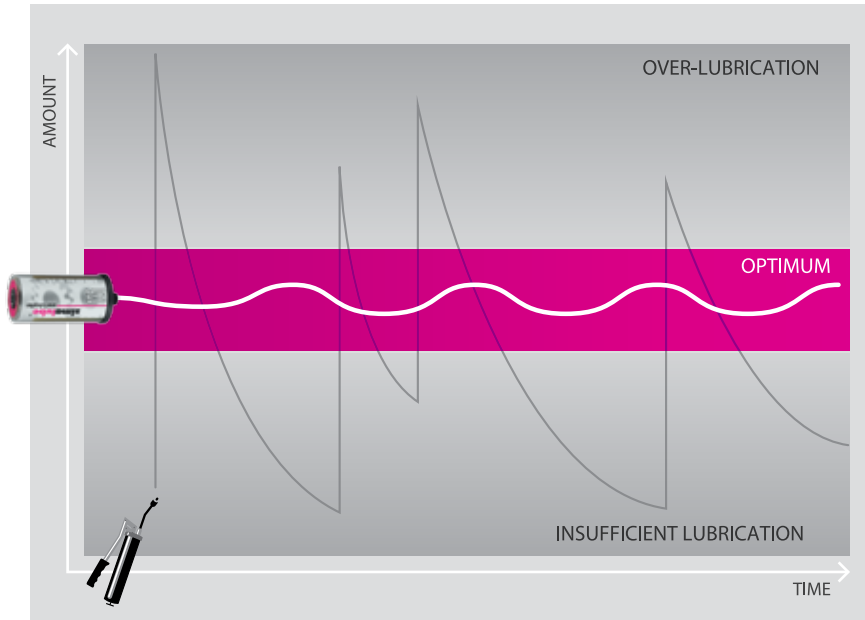

Continuous lubricant delivery with simalube effectively prevents insufficient or over-lubrication that often occurs with manual lubrication.

## Lower costs thanks to simalube

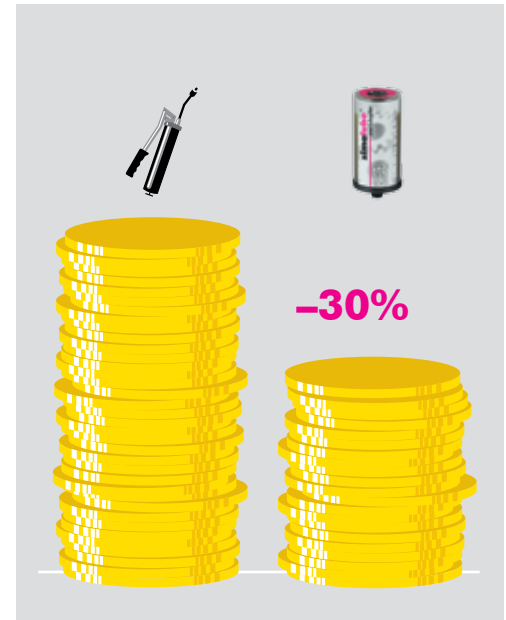

### Up to 30 percent lower costs:

- Time-saving and greater safety at work thanks to fewer maintenance intervals
- Longer machine service life and less unplanned down-time

## Benefits of automatic lubrication with simalube



### No more manual lubrication

- Saves time
- Greater work safety
- Hard-to-reach lubrication points are permanently supplied
- Lower lubricant consumption



### No under- or over-lubrication of components

- Less wear
- Less machine downtime
- Increased machine performance

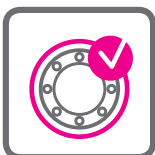

### Sealed, dustproof and waterproof system

- No more confusion of lubricants
- Reduced risk of contamination
- No contamination of lubrication points



### Compliance with international standards

- TÜV-tested and Ex certified in all zones
- Improved workplace safety
- No environmental impact thanks to recycling and disposal according to regulations

simalube –  
the lubrication expert



## simalube – the automatic single-point lubricator

Available in 5 sizes, simalube supplies various lubrication points with lubricant around the clock. Day in, day out – for up to one year.

### Take advantage of the simalube benefits

#### Reliability

- Lubrication points are continuously supplied with lubricant
- No lubrication point is missed
- Easy monitoring of the dispensing process thanks to the transparent housing

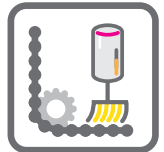

#### Environmental sustainability

- simalube can be refilled up to 3 times
- Easy disposal at end of dispensing cycle
- simalube lubricators do not contain toxic substances



#### Flexibility

- simalube is available in 5 sizes: 15, 30, 60, 125 and 250 ml
- Freely selectable dispensing cycle of 1 to 12 months
- Dispensing cycle can be modified anytime
- simalube is available filled or empty for self-filling

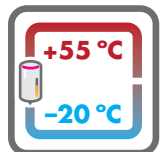

#### Unlimited range of uses (see pages 10/11)

- In confined and hard-to-reach spaces
- In any location, even underwater
- At ambient temperatures of –20 °C to +55 °C
- Numerous installation options thanks to a large range of accessories
- The standard lubricant range includes modern and proven high-performance lubricants for all applications (see pages 12/13)

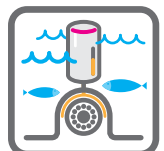

**TOM's  
TIP**

More technical information and user manual can be downloaded at  
[www.simatec.com/en/simalube](http://www.simatec.com/en/simalube)





## Components



## Specifications

Product	Automatic long-term grease and oil lubricator			
Power generation	Hydrogen gas producing drycell			
Working pressure	Max. 5 bar			
Adjustment	Stepless 1–12 months (for standard conditions)			
Operating temperature	–20 °C to +55 °C ambient temperature (Grease consistency changes with temperature)			
Storage temperature	Recommended at 20 °C ±5 °C			
Lubricator volume	30 ml	60 ml	125 ml	250 ml
Weight full	~82 g	~115 g	~190 g	~335 g
Weight empty	~55 g	~60 g	~75 g	~111 g
Refill	The 15–250 ml simalubes are refillable.			



## Certifications



**simalube 250**



**simalube 125**



**simalube 60**



**simalube 30**



To determine the size and time setting, use our free «Calculation Pro» program at [www.simatec.com/en/calpro](http://www.simatec.com/en/calpro)



## simalube 15 ml



## The smallest automatic lubricator

In confined spaces, the 15 ml simalube offers the perfect solution. With its compact size, it is unique on the global market as the smallest automatic lubricator. It functions the same as the larger simalube lubricators and offers the same advantages.



### Small size delivers big performance

- Space-saving thanks to compact size
- Robust aluminium enclosure
- Same refill, installation and function as other simalube lubricators
- Alternative to the simalube multipoint when less than 5 lubrication points are needed (see page 7)

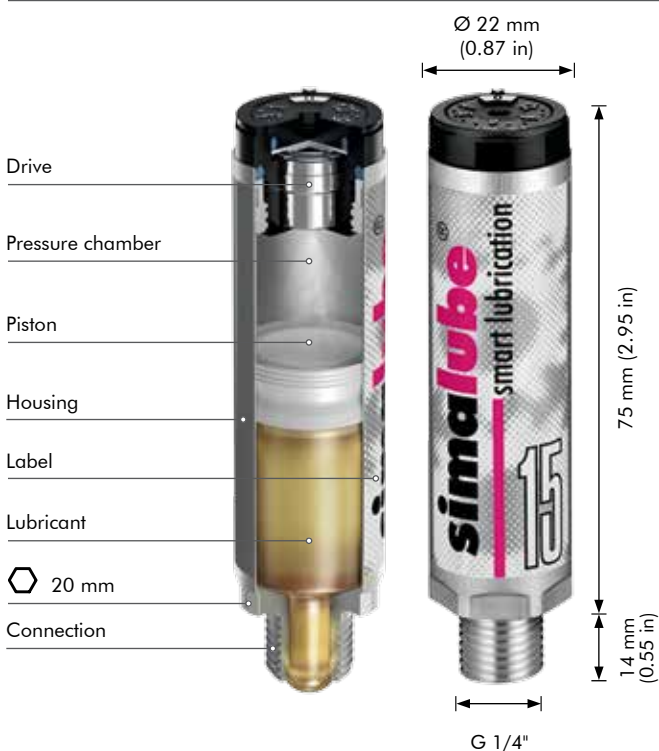
#### Dimensions



#### Specifications

Product	Automatic, long-term grease and oil lubricator
Power generation	Hydrogen gas producing drycell
Working pressure	Max. 5 bar
Adjustment	Stepless 1–12 months (for standard conditions)
Operating temperature	–20 °C to +55 °C ambient temperature (Grease consistency changes with temperature)
Storage temperature	Recommended at 20 °C ± 5 °C
Lubricator volume	15 ml
Weight full/empty	~36 g / ~22.5 g
Certifications	  

simalube multipoint



## Automatic multi-point lubricator

The simalube multipoint simultaneously supplies 5 lubrication points for up to one year in the same reliable way as the other proven simalube lubricators. Thanks to the snap-on connector, simalube multipoint can be replaced easily and quickly when empty.



### The versatile lubricator for linear guides

- 5×8 ml lubricant volume
- Allows very low lubricant delivery over a long period of time
- Snap-on connector for multipoint
- Quick couplings for connecting hoses
- Ideally suited for lubrication of linear guides

#### Dimensions



#### Specifications

Product	Automatic, multi-point, long-term lubricators for grease and oil
Power generation	Hydrogen gas producing drycell
Working pressure	Max. 5 bar
Adjustment	Stepless 1–12 months (for standard conditions)
Operating temperature	–20 °C to +55 °C ambient temperature (grease consistency changes with temperature)
Storage temperature	Recommended at 20 °C ± 5 °C
Lubricator volume	5×8 ml
Weight full/empty	~147 g / ~120 g
Certifications	  

## simalube IMPULSE



### Pressure booster up to 10 bar

The simalube IMPULSE ensures reliable lubrication in situations with high counter-pressure and long lubrication lines. With the automatic simalube lubricators, this pressure booster pumps greases and oils at up to 10 bar and 0.5 ml per impulse to the targeted lubrication point.

The LED display of the intelligent pressure booster provides information continuously about the current operating condition, and flashes green when the device is functioning correctly.

#### Powerhouse in compact form

##### Functionality

- Lubrication impulses of 0.5 ml of oil or grease up to NLGI 2 at a pressure of up to 10 bar
- Indication of operating condition via flashing LED status display (green/red)
- Dispensing time can be modified at any time via the lubricator
- Modular system, fully compatible with 60, 125 and 250 ml simalube lubricators
- The lubricator can be replaced without removing the simalube IMPULSE
- Gentle on all lubricants, as only the dosing quantity is under pressure

##### Diverse applications

- Can be installed outside of high-temperature or hazardous areas with tubes up to 4 metres long
- The compact format means it can be installed in very small spaces
- Functions perfectly in all positions, even underwater

##### Efficiency

- High cost savings thanks to reusability



**TOM's  
TIP**

More technical information and a video for simalube IMPULSE can be found at [www.simatec.com/en/impulse](http://www.simatec.com/en/impulse)





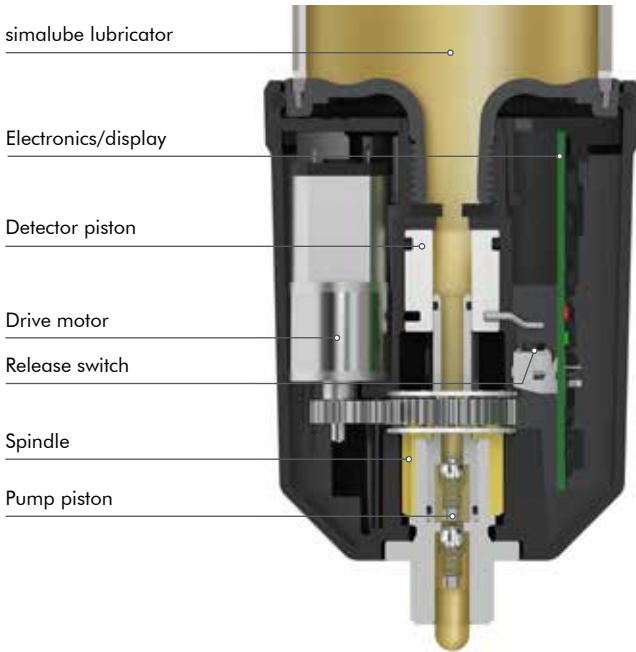

## Components



## Specifications

Product	Automatic pressure booster for the simalube lubricator
Drive system	Electromechanical
Power supply	Battery pack, 6 V 2.3 Ah
Function display	LED status display: green/red every 10 seconds
Dispensing volume	0.5 ml per stroke
Working pressure	Up to 10 bar
Time setting	1 to 12 months – determined by the setting on the simalube
Operating temperature	-10 °C to +55 °C
Lubrication rate	Depends on the size and settings of the simalube: 0.17 to 8.3 ml/day
Lubricator volume	According to lubricator: 60 ml, 125 ml or 250 ml
Lubricant	Grease up to NLGI 2 or oil
Installation position	Any
Weight	0.24 kg
Warranty & service life	3 years from the production date or until 10 simalube lubricators (125 ml) have been emptied
Tests/Approvals	 



### Install simalube IMPULSE



Install simalube IMPULSE. Insert battery pack, screw in simalube lubricator and adjust time.

### Simple refilling



Procure new battery pack and new cartridge, refill dispenser yourself ...



... or procure a new battery pack and new simalube lubricator.



# simalube applications

LIFTING DEVICES



The spindles of a lifting station for railway wagons and locomotives are lubricated with 125 ml simalube over 12 months.

FOOD INDUSTRY



The drive chain of a transport belt, which allows rolls to cool, is cleaned with special blue brushes and lubricated with 2 simalube SL18 in 30 and 60 ml sizes.

GRAVEL AND CONCRETE PLANTS



Two 250 ml simalube lubricators with brushes lubricate and clean the chain drive of a drum washing machine.

CRANES



125 ml simalube lubricators lubricate the rotating assembly of a crane.



GRAVEL AND CONCRETE PLANTS



The simalube IMPULSE with a 125 ml lubricator is used in gravel plants. The IMPULSE pushes the lubricant with a pressure of 10 bar through a 4-metre lubrication line.

ELEVATORS AND ESCALATORS



The 125 ml simalube maintains the guide rails of elevators and prevents dry friction. The system is attached directly to the cabin roof.

PRINTING INDUSTRY



A simalube multipoint can lubricate 5 linear guides of a cutting and paper stacking machine in a printing house.

WATER TREATMENT/SEWAGE TREATMENT PLANTS



60 ml lubricators on the electric motor and the drive shaft ensure continuous lubrication of a centrifugal pump.

RECYCLING



A 125 ml simalube lubricates the pedestal bearing of a conveyor belt.

MACHINERY AND PLANT ENGINEERING



15 ml simalube lubricators with brushes constantly supply the rack of a loading machine with oil. Additional 15 ml simalube lubricators lubricate the flange bearings with grease.



**TOM's  
TIP**

Many other applications can be found at [www.simatec.com/en/simalube-applications](http://www.simatec.com/en/simalube-applications)





# simalube standard lubricants and accessories

GREASE	NLGI	Thickener	Temperature range	Viscosity at 40 °C	Applications						
					Roller bearings	Plain bearings	Linear guides	Gears/Toothed racks	Spindles	Shaft seals	Chains
<b>SL01</b> Water-resistant, long-term grease	2	Lithium-calcium	-30 °C to 120 °C	118	+	+	•	•	+	+	-
<b>SL02</b> High-performance grease with MoS <sub>2</sub>	2	Lithium	-25 °C to 130 °C	370	•	+	-	+	-	-	-
<b>SL04</b> High-temperature grease for long-term lubrication (EP)	2	Inorganic thickener	-20 °C to 160 °C	540	+	•	-	•	•	-	-
<b>SL06</b> Water-resistant, fluid grease (EP)	0	Lithium-calcium	-20 °C to 120 °C	75	+	+	+	+	•	-	-
<b>SL09</b> Universal grease, readily biodegradable	2	Lithium-calcium	-20 °C to 100 °C	100	+	+	•	•	-	-	-
<b>SL10</b> Special grease for food, beverage and pharmaceutical industries	2	Aluminium complex	-40 °C to 130 °C	350	+	+	•	+	•	-	-
<b>SL12</b> Semi-fluid food industry grease	0	Aluminium complex	-40 °C to 130 °C	350	+	+	+	+	•	-	-
<b>SL24</b> Lubricating grease for a wide temperature range (EP)	2	Lithium complex	-30 °C to 140 °C	185	+	+	•	•	+	+	-
<b>SL25</b> High-temperature polyurea lubricating grease	2	Polyurea	-20 °C to 160 °C	110	+	•	-	•	•	-	-
<b>SL26</b> Calcium sulfonate complex grease (EP)	1.5	Calcium complex	-20 °C to 150 °C	460	+	+	-	•	•	-	-

+ recommended    • possible    - not recommended











**TOM's TIP**

Datasheets are available for all greases and oils at [www.simatec.com/en/lubricants](http://www.simatec.com/en/lubricants)





OIL	ISO-VG	Base oil	Temperature range	Viscosity at 40 °C	Applications						
					Roller bearings	Plain bearings	Linear guides	Gears/Toothed racks	Spindles	Shaft seals	Chains
											
<b>SL14</b> Chain oil (EP)	68	Mineral oil	-10 °C to 90 °C	68	-	•	•	-	-	-	+
<b>SL15</b> High-temperature chain oil (EP)	-	Synthetic oil	-30 °C to 250 °C	250	-	•	•	-	-	-	+
<b>SL16</b> Paraffinic lubricating oil	68	Mineral oil	-20 °C to 100 °C	68	-	•	•	-	-	-	+
<b>SL18</b> High performance lubricating oil for the food, animal feed and pharmaceutical industry 	220	Synthetic oil	-15 °C to 150 °C	220	-	•	•	-	-	-	+
<b>SL19</b> Organic chain oil	-	Rapeseed oil	-15 °C to 100 °C	60	-	•	•	-	-	-	+

+ recommended    • possible    - not recommended

## Application examples

The simalube can be easily installed anywhere and in any position with these accessories.

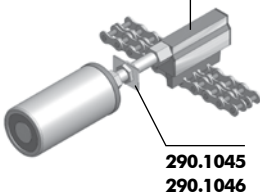
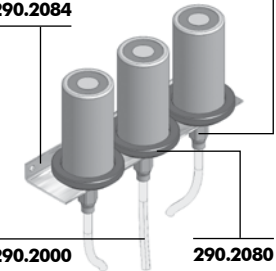
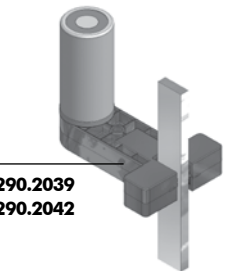
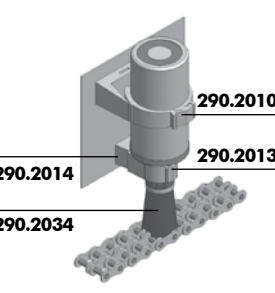
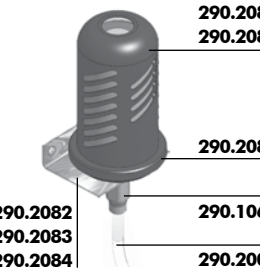
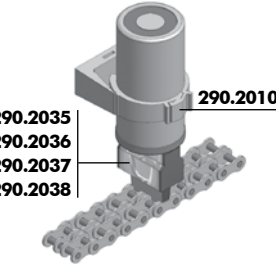
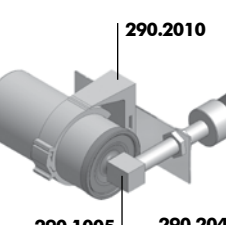
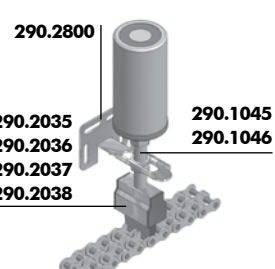
<p><b>Chain lubrication with lateral connection</b></p>  <p>290.2035-S 290.2036-S 290.2037-S 290.2038-S</p> <p>290.1045 290.1046</p>	<p><b>Mounting bracket</b></p>  <p>290.2082 290.2083 290.2084</p> <p>290.1060</p> <p>290.2000 290.2002 290.2004</p> <p>290.2080</p>	<p><b>Lubrication of elevator guides or wire ropes</b></p>  <p>290.2039 290.2042</p>	<p><b>Chain lubrication with round brush and two clamps</b></p>  <p>290.2010 290.2013</p> <p>290.2014 290.2034</p>
<p><b>Mounting support with protective cover for simalube</b></p>  <p>290.2081 290.2085</p> <p>290.2080</p> <p>290.2082 290.2083 290.2084</p> <p>290.1060</p> <p>290.2000 290.2002 290.2004</p>	<p><b>Chain lubrication with clamp</b></p>  <p>290.2010</p> <p>290.2035 290.2036 290.2037 290.2038</p>	<p><b>Round brush with 90° connection</b></p>  <p>290.2010</p> <p>290.1005    290.2041</p>	<p><b>Chain lubrication with bracket, universally adjustable</b></p>  <p>290.2800</p> <p>290.2035 290.2036 290.2037 290.2038</p> <p>290.1045 290.1046</p>

## Connections

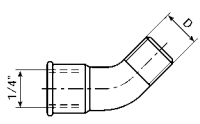
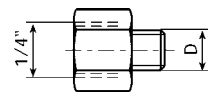
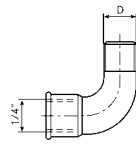
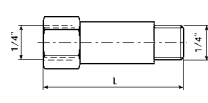
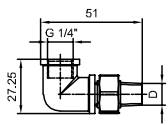
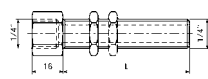
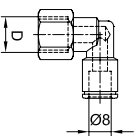
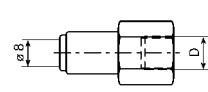
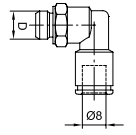
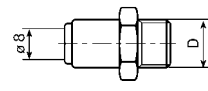
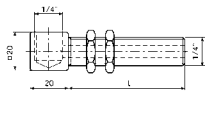
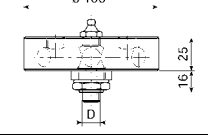
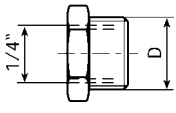
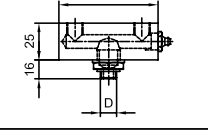
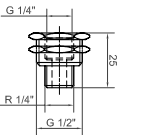
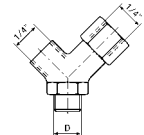
	<b>Bent connection 45°</b>  <b>D</b> R 1/4 <b>Nr.</b> 290.1001		<b>Reducing nipple</b> <table border="1"> <tr> <td><b>D</b></td> <td>G 1/8</td> <td>G 1/4</td> <td>M 6</td> <td>M 8</td> <td>M 8x1</td> </tr> <tr> <td><b>Nr.</b></td> <td>290.1020</td> <td>290.1021</td> <td>290.1022</td> <td>290.1023</td> <td>290.1024</td> </tr> </table> <table border="1"> <tr> <td><b>D</b></td> <td>M 10</td> <td>M 10x1</td> <td>M 12</td> <td>M 12x1.5</td> <td>UNF 1/4</td> </tr> <tr> <td><b>Nr.</b></td> <td>290.1025</td> <td>290.1026</td> <td>290.1027</td> <td>290.1028</td> <td>290.1121</td> </tr> </table>	<b>D</b>	G 1/8	G 1/4	M 6	M 8	M 8x1	<b>Nr.</b>	290.1020	290.1021	290.1022	290.1023	290.1024	<b>D</b>	M 10	M 10x1	M 12	M 12x1.5	UNF 1/4	<b>Nr.</b>	290.1025	290.1026	290.1027	290.1028	290.1121
<b>D</b>	G 1/8	G 1/4	M 6	M 8	M 8x1																						
<b>Nr.</b>	290.1020	290.1021	290.1022	290.1023	290.1024																						
<b>D</b>	M 10	M 10x1	M 12	M 12x1.5	UNF 1/4																						
<b>Nr.</b>	290.1025	290.1026	290.1027	290.1028	290.1121																						
	<b>Bent connection 90°</b>  <b>D</b> R 1/4 <b>Nr.</b> 290.1002		<b>Extension</b>  <table border="1"> <tr> <td><b>L</b></td> <td>10</td> <td>35</td> <td>50</td> <td>[mm]</td> </tr> <tr> <td><b>Nr.</b></td> <td>290.1021</td> <td>290.1040</td> <td>290.1041</td> <td></td> </tr> </table>	<b>L</b>	10	35	50	[mm]	<b>Nr.</b>	290.1021	290.1040	290.1041															
<b>L</b>	10	35	50	[mm]																							
<b>Nr.</b>	290.1021	290.1040	290.1041																								
	<b>Bent connection 90° swiveling</b>  <b>D</b> R 1/4 <b>Nr.</b> 290.1004		<b>Screwed connection with hole,</b> 25 mm incl. 1 nut / 60 mm, incl. 2 nuts  <table border="1"> <tr> <td><b>L</b></td> <td>25</td> <td>60</td> <td>[mm]</td> </tr> <tr> <td><b>Nr.</b></td> <td>290.1045</td> <td>290.1046</td> <td></td> </tr> </table>	<b>L</b>	25	60	[mm]	<b>Nr.</b>	290.1045	290.1046																	
<b>L</b>	25	60	[mm]																								
<b>Nr.</b>	290.1045	290.1046																									
	<b>Rotary elbow,</b> for hose Ø 8 mm  <b>D</b> G 1/4 <b>Nr.</b> 290.1003		<b>Quick connection,</b> for hose Ø 8 mm  <b>D</b> G 1/4 <b>Nr.</b> 290.1060																								
	<b>Rotary elbow,</b> for hose Ø 8 mm  <b>D</b> G 1/8 G 1/4 <b>Nr.</b> 290.1007 290.1008		<b>Quick connection,</b> for hose Ø 8 mm  <b>D</b> G 1/8 G 1/4 G 3/8 <b>Nr.</b> 290.1070 290.1071 290.1072																								
	<b>90° connection with thread,</b> incl. 2 nuts (only for oil)  <b>L</b> 70 [mm] <b>Nr.</b> 290.1005		<b>4-fold adapter</b>  <b>D</b> G 1/2 G 1/4 <b>Nr.</b> 290.4100 290.4101																								
	<b>Connecting nipple</b>  <b>D</b> G 3/8 G 1/2 <b>Nr.</b> 290.1010 290.1011		<b>2-fold adapter</b>  <b>D</b> G 1/2 G 1/4 <b>Nr.</b> 290.4102 290.4103																								
	<b>Fixation nipple G 1/2" - R 1/4"</b>  <b>L</b> 25 [mm] <b>Nr.</b> 290.1015		<b>Y-manifold,</b> contains reduction art. 290.1021  <b>D</b> R 1/4 <b>Nr.</b> 290.1050																								

## Lubricator accessories and miscellaneous

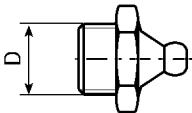
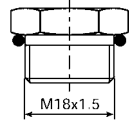
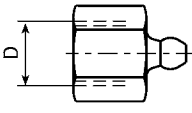
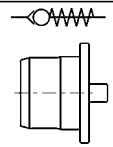
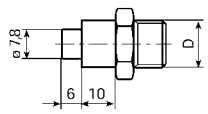
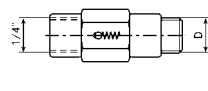
	<b>Filling nipple,</b> for cleaning and filling of grease lines  <b>D</b> R 1/4 <b>Nr.</b> 290.3011		<b>Gas generator,</b> for refilling  <table border="1"> <tr> <td></td> <td>15 ml</td> <td>30 ml</td> <td>60 ml</td> <td>125 ml</td> <td>250 ml</td> </tr> <tr> <td><b>Nr.</b></td> <td>220.5002</td> <td>220.5004</td> <td>220.5006</td> <td>220.5008</td> <td>220.5010</td> </tr> </table>		15 ml	30 ml	60 ml	125 ml	250 ml	<b>Nr.</b>	220.5002	220.5004	220.5006	220.5008	220.5010
	15 ml	30 ml	60 ml	125 ml	250 ml										
<b>Nr.</b>	220.5002	220.5004	220.5006	220.5008	220.5010										
	<b>Refill nipple,</b> for refilling of simalube  <b>D</b> G 1/4 <b>Nr.</b> 290.3012		<b>Non-return valve plug,</b> Plastic  <b>Nr.</b> 290.5060												
	<b>Refill nipple,</b> to grease gun filler for filling simalube  <b>D</b> R 1/4 R 3/8 <b>Nr.</b> 290.3013 290.3014		<b>Non-return valve</b>  <b>D</b> G 1/8 G 1/4 <b>Nr.</b> 290.2020 290.2021												

## Safety accessories

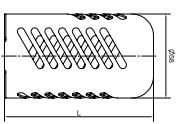
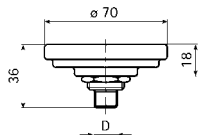
	<b>Protective cover,</b> to mounting support art. 290.2080  <table border="1"> <tr> <td></td> <td>≤125 ml</td> <td>250 ml</td> </tr> <tr> <td><b>L</b></td> <td>105</td> <td>195</td> </tr> <tr> <td><b>Nr.</b></td> <td>290.2081</td> <td>290.2085</td> </tr> </table>		≤125 ml	250 ml	<b>L</b>	105	195	<b>Nr.</b>	290.2081	290.2085		<b>Mounting support,</b> for all simalube sizes  <b>D</b> R 1/4 <b>Nr.</b> 290.2080
	≤125 ml	250 ml										
<b>L</b>	105	195										
<b>Nr.</b>	290.2081	290.2085										

## Brushes

	<p><b>Round brush</b></p> <p><b>D x L</b> Ø 25 x 45 [mm]  <b>Nr.</b> 290.2034</p>		<p><b>Brush lateral connection,</b> SFN for food applications</p> <table border="1"> <tr> <td><b>L</b></td> <td>25</td> <td>40</td> <td>70</td> <td>100</td> <td>[mm]</td> </tr> <tr> <td><b>Nr.</b></td> <td>290.2038-S</td> <td>290.2035-S</td> <td>290.2036-S</td> <td>290.2037-S</td> <td></td> </tr> <tr> <td><b>Nr.</b></td> <td>290.2038-SFN</td> <td>290.2035-SFN</td> <td>290.2036-SFN</td> <td>290.2037-SFN</td> <td></td> </tr> </table>	<b>L</b>	25	40	70	100	[mm]	<b>Nr.</b>	290.2038-S	290.2035-S	290.2036-S	290.2037-S		<b>Nr.</b>	290.2038-SFN	290.2035-SFN	290.2036-SFN	290.2037-SFN			
<b>L</b>	25	40	70	100	[mm]																		
<b>Nr.</b>	290.2038-S	290.2035-S	290.2036-S	290.2037-S																			
<b>Nr.</b>	290.2038-SFN	290.2035-SFN	290.2036-SFN	290.2037-SFN																			
	<p><b>Round brush short</b></p> <p><b>D x L</b> Ø 25 x 15 [mm]  <b>Nr.</b> 290.2041</p>		<p><b>Elevator brush,</b> 5-16 mm, height 32 mm</p> <p><b>Elevator brush,</b> 16-32 mm, height 32 mm</p> <table border="1"> <tr> <td><b>Nr.</b></td> <td>290.2039</td> <td><b>Nr.</b></td> <td>290.2044</td> </tr> </table>	<b>Nr.</b>	290.2039	<b>Nr.</b>	290.2044																
<b>Nr.</b>	290.2039	<b>Nr.</b>	290.2044																				
	<p><b>Brush, FN for food applications</b></p> <table border="1"> <tr> <td><b>L</b></td> <td>25</td> <td>40</td> <td>70</td> <td>100</td> <td>[mm]</td> </tr> <tr> <td><b>Nr.</b></td> <td>290.2038</td> <td>290.2035</td> <td>290.2036</td> <td>290.2037</td> <td></td> </tr> <tr> <td><b>Nr.</b></td> <td>290.2038-FN</td> <td>290.2035-FN</td> <td>290.2036-FN</td> <td>290.2037-FN</td> <td></td> </tr> </table>	<b>L</b>	25	40	70	100	[mm]	<b>Nr.</b>	290.2038	290.2035	290.2036	290.2037		<b>Nr.</b>	290.2038-FN	290.2035-FN	290.2036-FN	290.2037-FN			<p><b>Elevator brush small,</b> 5-16 mm, height 32 mm</p> <table border="1"> <tr> <td><b>Nr.</b></td> <td>290.2042</td> </tr> </table>	<b>Nr.</b>	290.2042
<b>L</b>	25	40	70	100	[mm]																		
<b>Nr.</b>	290.2038	290.2035	290.2036	290.2037																			
<b>Nr.</b>	290.2038-FN	290.2035-FN	290.2036-FN	290.2037-FN																			
<b>Nr.</b>	290.2042																						

## Installation accessories

	<p><b>Hose,</b> available by the metre</p> <p><b>L</b> per metre Ø 8/6 mm  <b>Nr.</b> 290.2000/...m</p>		<p><b>Adapter for clamp (60 mm),</b> Plastic</p> <table border="1"> <tr> <td><b>D</b></td> <td>50</td> <td>[mm]</td> </tr> <tr> <td><b>Nr.</b></td> <td>290.2012</td> <td></td> </tr> </table>	<b>D</b>	50	[mm]	<b>Nr.</b>	290.2012										
<b>D</b>	50	[mm]																
<b>Nr.</b>	290.2012																	
	<p><b>Hose for temperatures up to 260 °C,</b> available by the meter</p> <p><b>L</b> per metre Ø 8/6 mm  <b>Nr.</b> 290.2002/...m</p>		<p><b>Distance holder,</b> to clamp for round brush art. 290.2013</p> <table border="1"> <tr> <td><b>H</b></td> <td>15</td> <td>[mm]</td> </tr> <tr> <td><b>Nr.</b></td> <td>290.2014</td> <td></td> </tr> </table>	<b>H</b>	15	[mm]	<b>Nr.</b>	290.2014										
<b>H</b>	15	[mm]																
<b>Nr.</b>	290.2014																	
	<p><b>Hose for small bend radius,</b> available by the metre</p> <p><b>L</b> per metre Ø 8/6 mm  <b>Nr.</b> 290.2004/...m</p>		<p><b>Bracket,</b> to mounting support simalube art. 290.2080</p> <table border="1"> <tr> <td></td> <td>1x</td> <td>3x</td> <td>5x</td> <td></td> </tr> <tr> <td><b>L</b></td> <td>75</td> <td>240</td> <td>390</td> <td>[mm]</td> </tr> <tr> <td><b>Nr.</b></td> <td>290.2082</td> <td>290.2083</td> <td>290.2084</td> <td></td> </tr> </table>		1x	3x	5x		<b>L</b>	75	240	390	[mm]	<b>Nr.</b>	290.2082	290.2083	290.2084	
	1x	3x	5x															
<b>L</b>	75	240	390	[mm]														
<b>Nr.</b>	290.2082	290.2083	290.2084															
	<p><b>Clamp for simalube/round brush,</b> Plastic</p> <table border="1"> <tr> <td><b>D</b></td> <td>22 (SL 15 ml)</td> <td>28 (round brush)</td> <td>50 (SL 30-250 ml)</td> <td>[mm]</td> </tr> <tr> <td><b>Nr.</b></td> <td>290.2015</td> <td>290.2013</td> <td>290.2010</td> <td></td> </tr> </table>	<b>D</b>	22 (SL 15 ml)	28 (round brush)	50 (SL 30-250 ml)	[mm]	<b>Nr.</b>	290.2015	290.2013	290.2010			<p><b>Bracket,</b> universally adjustable</p> <table border="1"> <tr> <td><b>Nr.</b></td> <td>290.2800</td> </tr> </table>	<b>Nr.</b>	290.2800			
<b>D</b>	22 (SL 15 ml)	28 (round brush)	50 (SL 30-250 ml)	[mm]														
<b>Nr.</b>	290.2015	290.2013	290.2010															
<b>Nr.</b>	290.2800																	
	<p><b>Magnetic fixture,</b> for clamps</p> <table border="1"> <tr> <td><b>Nr.</b></td> <td>290.2019</td> </tr> </table>	<b>Nr.</b>	290.2019															
<b>Nr.</b>	290.2019																	

## simalube multipoint installation components

	<p><b>Quick connection,</b> for hose Ø 4 mm</p> <table border="1"> <tr> <td><b>D</b></td> <td>R 1/8</td> <td>R 1/4</td> <td>M 5</td> <td>M 6</td> </tr> <tr> <td><b>Nr.</b></td> <td>290.1170</td> <td>290.1171</td> <td>290.1172</td> <td>290.1173</td> </tr> </table>	<b>D</b>	R 1/8	R 1/4	M 5	M 6	<b>Nr.</b>	290.1170	290.1171	290.1172	290.1173		<p><b>Hose,</b> available by the metre</p> <table border="1"> <tr> <td><b>L</b></td> <td>per metre</td> <td>Ø 4/2.7 mm</td> </tr> <tr> <td><b>Nr.</b></td> <td>290.2100/...m</td> <td></td> </tr> </table>	<b>L</b>	per metre	Ø 4/2.7 mm	<b>Nr.</b>	290.2100/...m	
<b>D</b>	R 1/8	R 1/4	M 5	M 6															
<b>Nr.</b>	290.1170	290.1171	290.1172	290.1173															
<b>L</b>	per metre	Ø 4/2.7 mm																	
<b>Nr.</b>	290.2100/...m																		
	<p><b>Connection SLM</b></p> <table border="1"> <tr> <td><b>D</b></td> <td>5 x Ø 4 mm</td> </tr> <tr> <td><b>Nr.</b></td> <td>290.2900</td> </tr> </table>	<b>D</b>	5 x Ø 4 mm	<b>Nr.</b>	290.2900														
<b>D</b>	5 x Ø 4 mm																		
<b>Nr.</b>	290.2900																		

## Grease cartridges and oil bottles for prelubrication

	<p><b>Grease cartridge,</b> 400 ml</p> <table border="1"> <tr> <td></td> <td>SL01</td> <td>SL02</td> <td>SL04</td> <td>SL06</td> <td>SL09</td> </tr> <tr> <td><b>Nr.</b></td> <td>290.7001</td> <td>290.7002</td> <td>290.7004</td> <td>290.7006</td> <td>290.7009</td> </tr> <tr> <td></td> <td>SL10</td> <td>SL24</td> <td>SL25</td> <td>SL26</td> <td></td> </tr> <tr> <td><b>Nr.</b></td> <td>290.7010</td> <td>290.7024</td> <td>290.7025</td> <td>290.7026</td> <td></td> </tr> </table>		SL01	SL02	SL04	SL06	SL09	<b>Nr.</b>	290.7001	290.7002	290.7004	290.7006	290.7009		SL10	SL24	SL25	SL26		<b>Nr.</b>	290.7010	290.7024	290.7025	290.7026			<p><b>Oil bottle,</b> 0.5 l</p> <table border="1"> <tr> <td></td> <td>SL14</td> <td>SL15</td> <td>SL16</td> <td>SL18</td> <td>SL19</td> </tr> <tr> <td><b>Nr.</b></td> <td>290.7114</td> <td>290.7115</td> <td>290.7116</td> <td>290.7118</td> <td>290.7119</td> </tr> </table>		SL14	SL15	SL16	SL18	SL19	<b>Nr.</b>	290.7114	290.7115	290.7116	290.7118	290.7119
	SL01	SL02	SL04	SL06	SL09																																		
<b>Nr.</b>	290.7001	290.7002	290.7004	290.7006	290.7009																																		
	SL10	SL24	SL25	SL26																																			
<b>Nr.</b>	290.7010	290.7024	290.7025	290.7026																																			
	SL14	SL15	SL16	SL18	SL19																																		
<b>Nr.</b>	290.7114	290.7115	290.7116	290.7118	290.7119																																		

## simalube IMPULSE accessories

	<p><b>simalube IMPULSE,</b> pressure booster</p> <table border="1"> <tr> <td><b>Nr.</b></td> <td>230.1000</td> </tr> </table>	<b>Nr.</b>	230.1000		<p><b>Battery pack</b></p> <table border="1"> <tr> <td><b>Power</b></td> <td>6 V 2.3 Ah</td> </tr> <tr> <td><b>Nr.</b></td> <td>230.5000</td> </tr> </table>	<b>Power</b>	6 V 2.3 Ah	<b>Nr.</b>	230.5000
<b>Nr.</b>	230.1000								
<b>Power</b>	6 V 2.3 Ah								
<b>Nr.</b>	230.5000								

## simatec ag

Stadthof 2, CH-3380 Wangen a. Aare

Tel.: +41 (0)32 636 50 00

Fax: +41 (0)32 636 50 19

welcome@simatec.com

www.simatec.com



simalube  
video

## simatec – innovative solutions that deliver outstanding customer benefits

simatec is an international, Swiss family enterprise. Since its founding in 1983, this motivated team has been developing, manufacturing and marketing innovative products for the maintenance of rolling bearings under the brand names of simalube, simatherm and simatool.

The direct customer benefits are always at the forefront. Using newly developed technologies, simatec simplifies complex processes and reduces routine maintenance for tens of thousands of machines around the globe.

Select trading partners sell simatec maintenance products around the world. They provide professional service and individual, expert advice.

## Maintenance products by simatec – industrial technology



### Lubricators

The simalube lubricator provides automatic lubrication over a period of one month to a year and can be adjusted in an infinitely variable manner. simalube supplies every lubricating point with the ideal amount of lubricant – be it oil or grease – so that subsequent manual lubrication is no longer needed and maintenance costs are reduced in the long term.

**simalube**<sup>®</sup>  
smart lubrication



### Induction Heaters

simatherm induction heaters heat circular metal parts, such as roller bearings, in a very short amount of time, so they can be installed quickly and efficiently. The inductive heating of metallic workpieces makes sense from both an economical and ecological perspective. simatec is the world's leading manufacturer of these types of heaters.

**simatherm**<sup>®</sup>  
smart mounting



### Tools

The simatool toolkits enable the fast installation and removal of roller bearings and seals. They are used all over the world in machine and maintenance workshops within all industries.

**simatool**<sup>®</sup>  
smart tools